

ISBT 128 Education and Training

Feb 23, 2012

The need is constant.
The gratification is instant.
Give blood.™



**American
Red Cross**

- A Brief History
- What is ISBT 128?
- Who is ICCBBA?
- The ISBT 128 Label Quadrants
- Label Bar Codes
- Questions and Answers



1970s – Codabar was conceived and implemented

1980s – Need for an international standard

Effort funded by American Red Cross and aabb

1990s – ISBT 128 was to fulfill this need

2000s – U.S. began to transition to ISBT 128

CBC of Kansas City went live on July 1, 2003

2010s – Remainder of U.S. will add ISBT 128

- FDA allows either Codabar or ISBT 128
- AABB* accredited facilities must use ISBT 128

*AABB is formerly known as the "American Association of Blood Banks." The association instituted a name change in 2005 and is now known only by its acronym, AABB

- ISBT = International Society of Blood Transfusion
- 128 = Code 128
- Put them together = an information system that standardizes blood product labeling
- Every blood product has a label that is divided into four quadrants
- ICCBBA* – Administers and manages ISBT 128

*ICCBBA was formerly known as the International Council for Commonality in Blood Banking Automation." A name change was instituted and is now known only by its acronym, ICCBBA.

A barcode is both black BARS and white (blank) SPACES

Scanners reads the bars and spaces and convert them into zeros and ones

The zeros and ones are then converted into meaningful data such as O POSITIVE, CMV Negative, an expiration date or the anticoagulant inside.

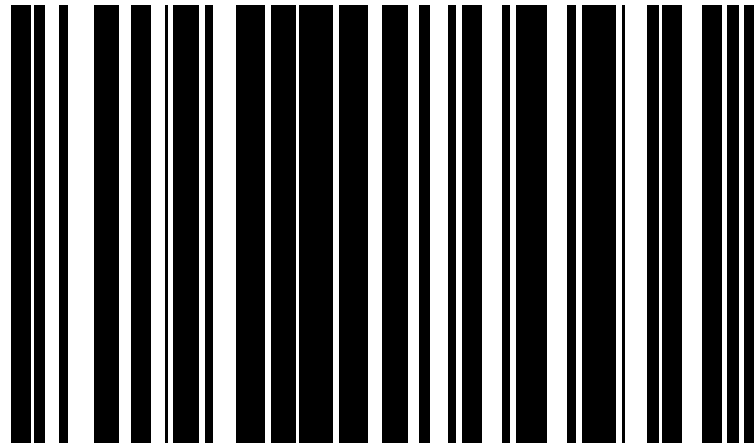

Simple barcode

the characters AB:

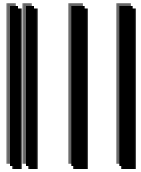

1 narrow bar,
1 narrow space,
1 narrow bar,
1 wide space,
1 wide bar,
1 wide space,
1 wide bar.

Code 128

the characters AB:



1X bar,
1X space,
2X bar.



Code 128

ISBT 128 – Label Quadrants

The ISBT 128 product label is divided into four quadrants

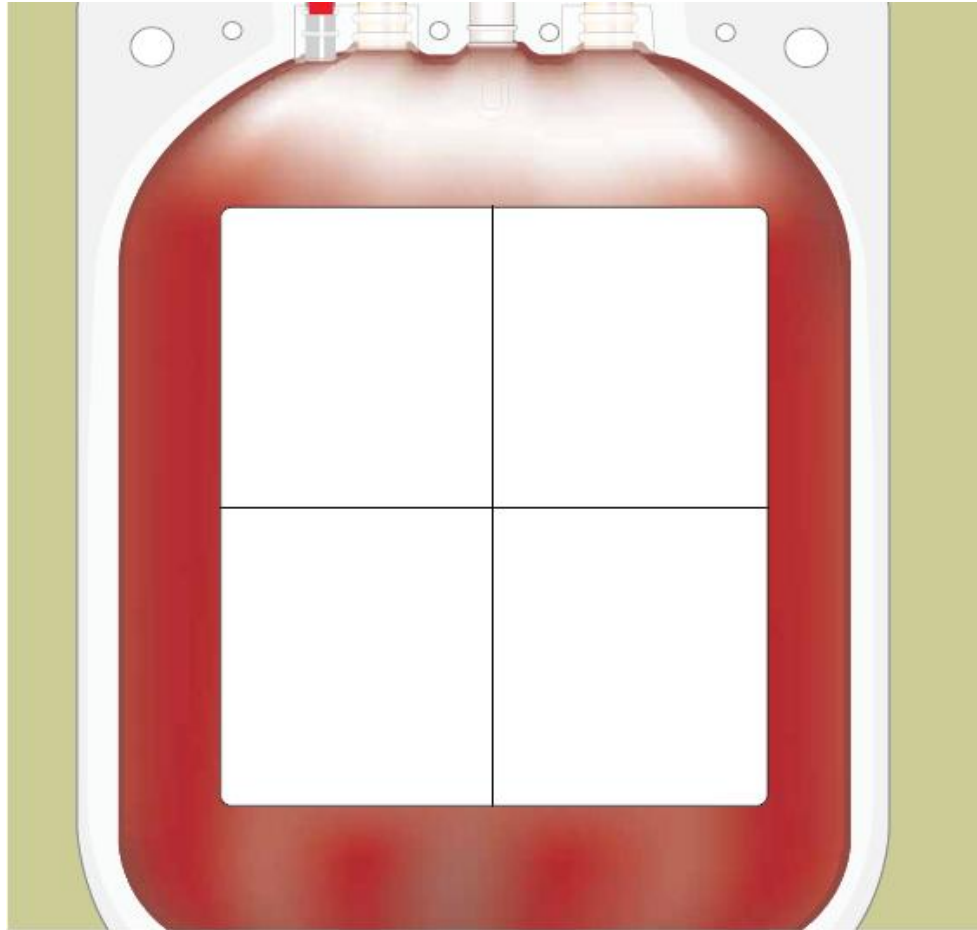

ISBT 128 – Label Quadrants

Each quadrant has a purpose and required bar codes

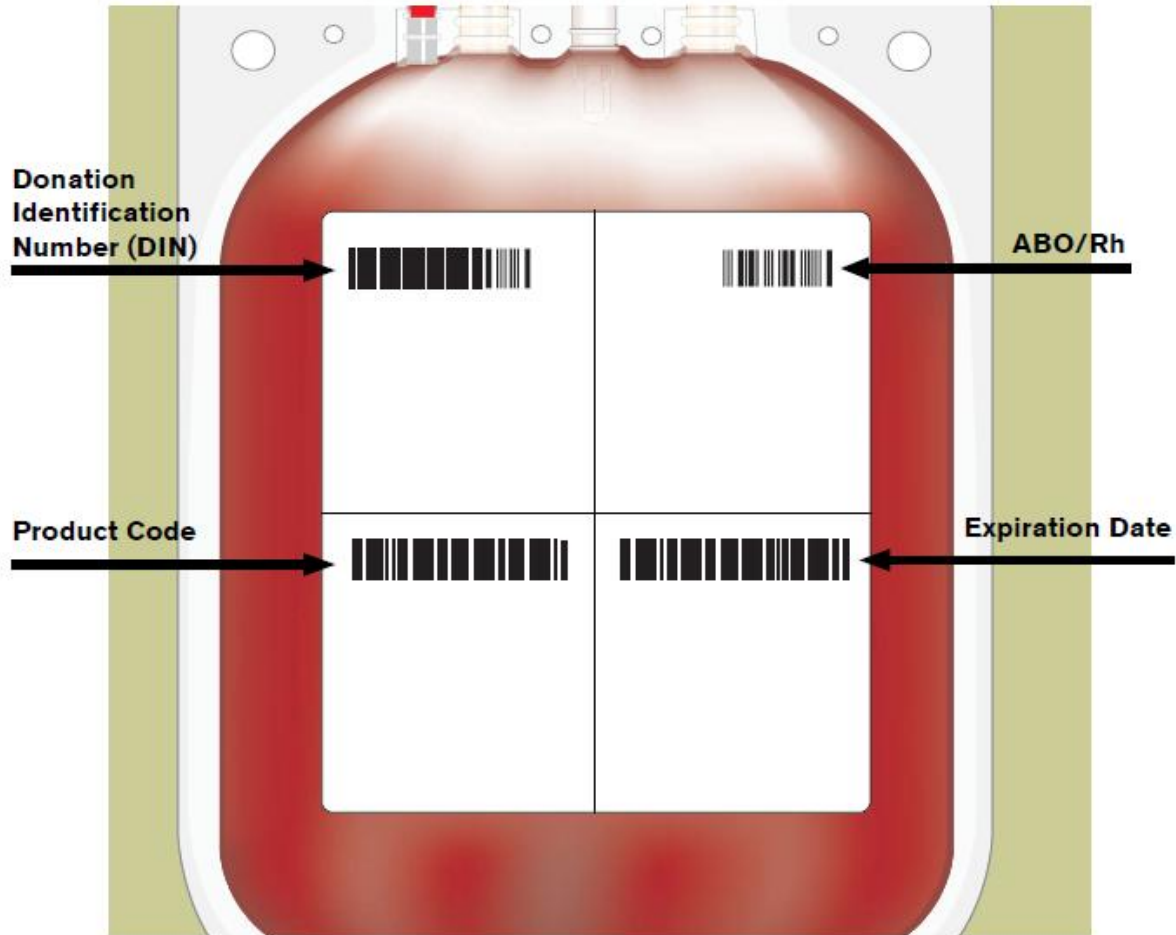

ISBT 128 – The Full Face Label



ISBT 128 and Codabar Side-by-Side

Codabar

ISBT 128

Region Code 24

Unique Unit Identifier
WBN DIN

Product Codes

US License #

FDA Registration #

ANTI-CMV NEGATIVE

24 XX12345

EXPIRES 08/04/10

AS-1 RED BLOOD CELLS
ADENINE-SALINE ADDED
LEUKOCYTES REDUCED

16.9 mEq Sodium added
From 500 mL
CPD Whole Blood
Store at 1 to 6 C

04710

Rh POSITIVE

THE AMERICAN NATIONAL RED CROSS
Washington, DC 20006
U.S. License # 190

Collected and Processed by
American Red Cross Blood Services

River Valley Region
Louisville, KY 40201

Registration # 1073003

See circular of information for indications, contraindications, cautions and methods of infusion.

VOLUNTEER DONOR

This product may transmit infectious agents.
PROPERLY IDENTIFY INTENDED RECIPIENT.
190

W2024 10 123456 8(5) 5100

The American National Red Cross
Washington, DC 20006
FDA Registration Number 1073003
US License Number 0190

Properly identify Intended Recipient
See Circular of information for indications, contraindications, cautions and methods of infusion.
This product may transmit infectious agents.
Rx Only
VOLUNTEER DONOR

Rh Positive

0038V00

0102102359
04 AUG 2010

RED BLOOD CELLS

ADENINE-SALINE (AS-1) ADDED
LEUKOCYTES REDUCED
From 500 mL CPD Whole Blood
Store at 1 to 6 C

NOT VALID FOR SCANNING

NOT VALID FOR SCANNING

ISBT 128 and Codabar Side-by-Side

Codabar

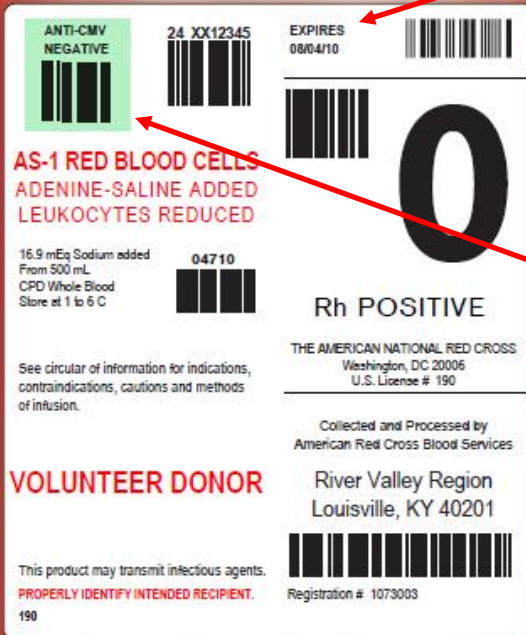

ANTI-CMV
NEGATIVE

24 XX12345

EXPIRES
08/04/10

AS-1 RED BLOOD CELLS
ADENINE-SALINE ADDED
LEUKOCYTES REDUCED

16.9 mEq Sodium added
From 500 mL
CPD Whole Blood
Store at 1 to 6 C

04710

Rh POSITIVE

THE AMERICAN NATIONAL RED CROSS
Washington, DC 20006
U.S. License # 190

Collected and Processed by
American Red Cross Blood Services

River Valley Region
Louisville, KY 40201

Registration # 1073003

This product may transmit infectious agents.
PROPERLY IDENTIFY INTENDED RECIPIENT.
190

NOT VALID FOR SCANNING

Expiration Date

CMV Neg

ISBT 128



W2024 10 123456 5100

The American National Red Cross
Washington, DC 20006
FDA Registration Number 1073003
U.S. License Number 0190

Properly Identify Intended Recipient
See Circular of Information for indications,
contraindications, cautions and methods of infusion.
This product may transmit infectious agents.
Rx Only
VOLUNTEER DONOR

Rh Positive

00330/00

0102102359
04 AUG 2010

Expiration Date/Time

RED BLOOD CELLS

ADENINE-SALINE (AS-1) ADDED
LEUKOCYTES REDUCED
From 500 mL CPD Whole Blood
Store at 1 to 6 C

Negative for antibodies to CMV

NOT VALID FOR SCANNING

Concatenation



ISBT 128 – The DIN and the FIN

The DIN is a 13 character alpha-numeric sequence assigned to each and every donation. By embedding the FIN within the DIN the unit and the facility that collected it are forever linked.

The FIN is the first five characters of the DIN. Each registered blood facility is given a unique five character FIN by ICCBBA.

For example, in the diagram below the Red Cross River Valley Region in Louisville Kentucky has been assigned a FIN # of W2024.

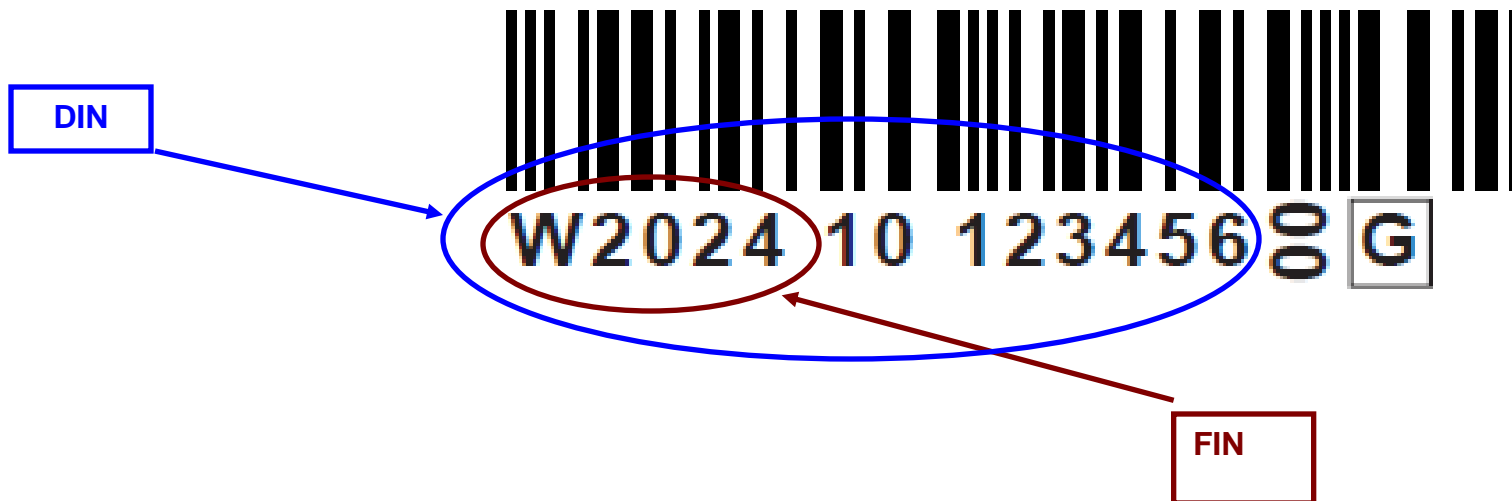

ISBT 128 – Donation Identification Number (DIN)



W2024 10 123456 00 G

W	Position 1	Country identifier. A capital “W” has been assigned for the U.S.
2000	Positions 2 to 5	A facility identifier for the American Red Cross. W2024 identifies the River Valley Region.
YY	Positions 6 and 7	A two-digit year of collection (e.g., 2010 would be represented as “10”)
NNNN NN	Positions 8 to 13	A sequential six-digit number assigned to each blood collection
00	Positions 14 and 15	Flag characters for process control; NEVER USED IN THE US.
G	Letter in a box is checksum character	Used only when the number is manually entered into the system as a check against errors

ISBT 128 – Facility Identification Number (FIN)

ICCBBA FIN	Region	FDA LICENSE NUMBER (ARC HAS 1 LICENSE)	FDA Registration #
W2001	New York-Penn	190	2438445
W2002	Central Plains	190	1973042
W2003	Southern	190	1073000
W2004	Massachusetts	190	1270026
W2006	Southern California	190	2072994
W2007	Arizona	190	2072997
W2009	Midwest	190	1973037
W2011	Missouri-Illinois	190	1973035
W2012	Carolinas	190	1073007
W2013	Southeastern Michigan	190	1873044
W2016	Central Ohio	190	1573013



- Barcode and eye readable DIN
- Collection center ID (FIN)
- FDA Registration Number
- US License Number
- Instructions for use
- Type of donor

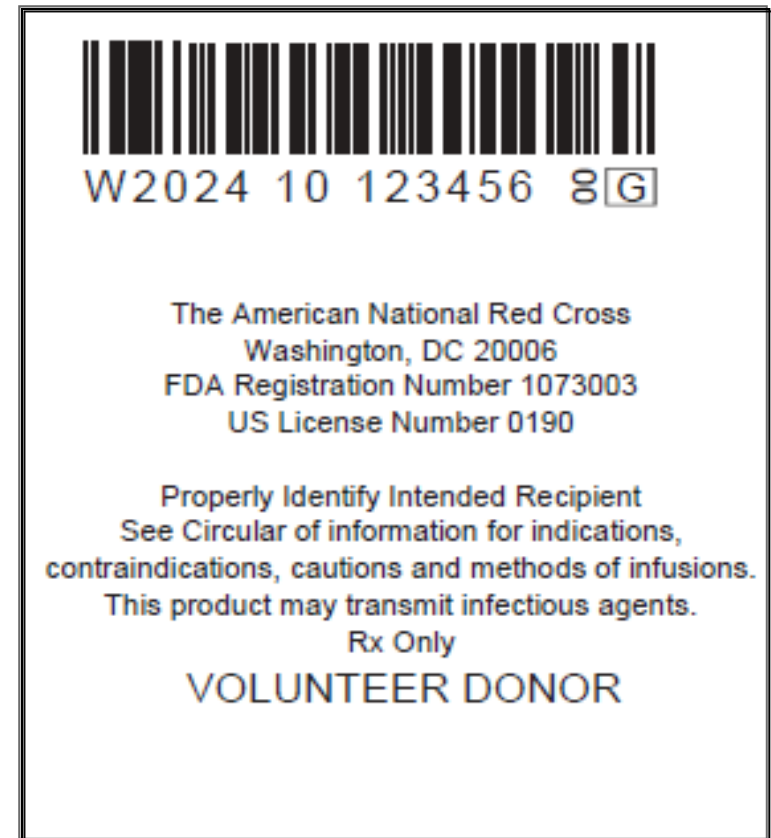

- Barcode and eye readable product code
- Product description
- Additional information about the product such as volume, storage temperature, etc.

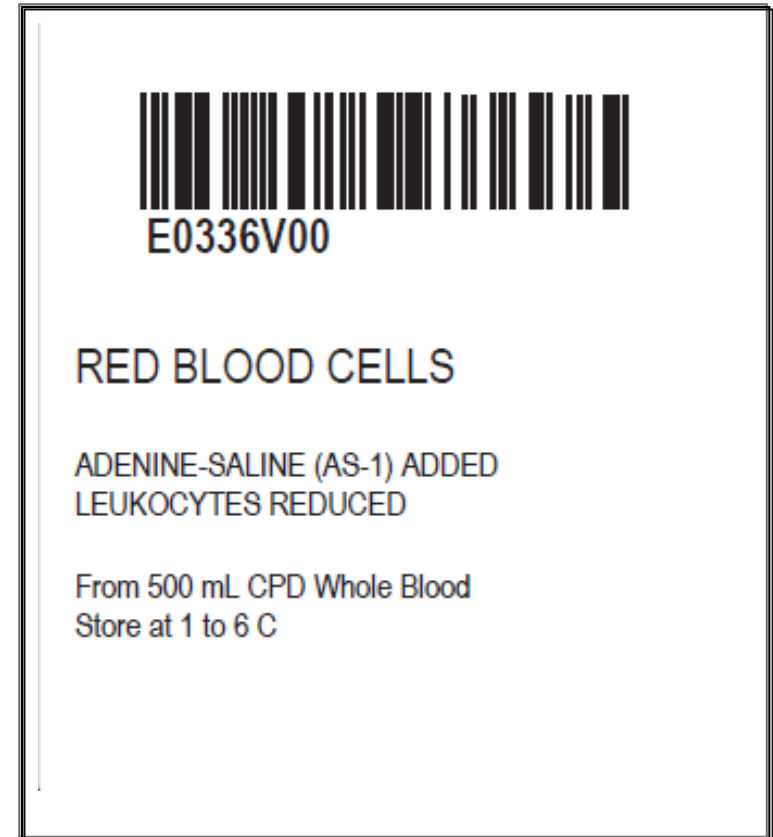

ISBT 128 Product Code



ISBT 128 Product Bar Code
(component code)

Donation Type Abbreviation

V= Volunteer
1 = Autologous
X = Autologous-Biohazard
R = Researcher
D = Directed-Eligible for Crossover

ISBT 128 Divided Code

00 = Volunteer (<i>Not Divided</i>)
A0 = Volunteer-Divided Part 1
B0 = Volunteer-Divided Part 2
C0 = Volunteer-Divided Part 3
D0 = Volunteer Divided Part 4

- Barcode and eye readable blood type



- Autologous label

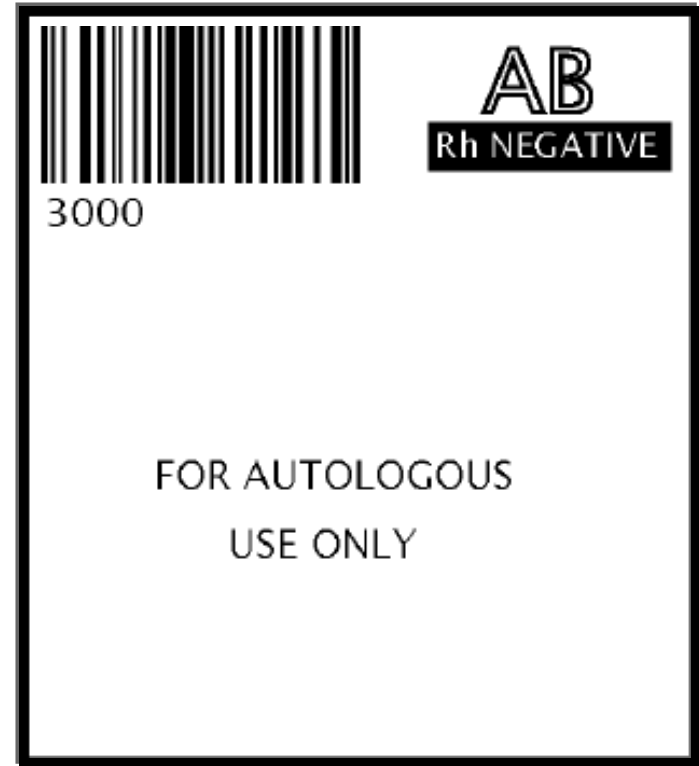

- Autologous label



- Barcode and eye readable blood type



ISBT 128 – Upper Right Quadrant

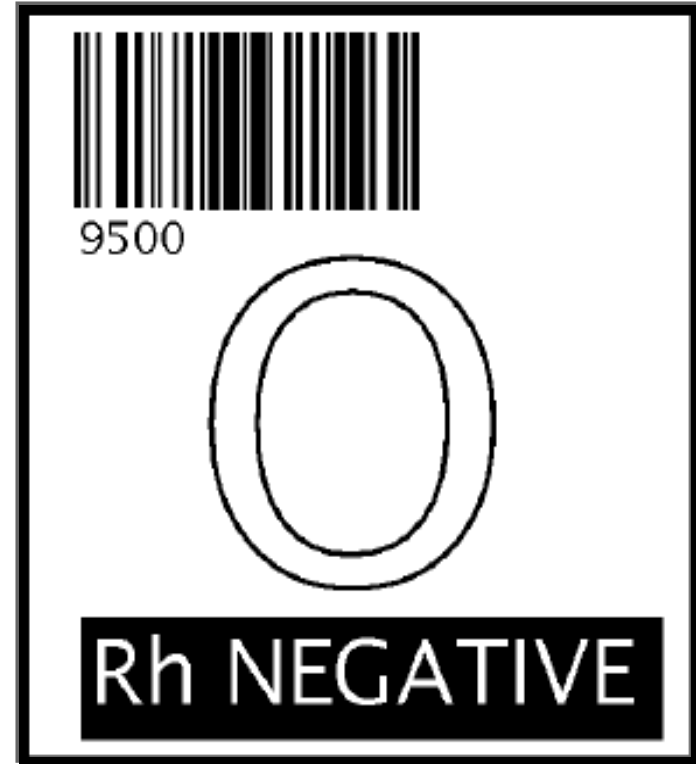

NOT VALID FOR SCANNING

ISBT 128 – Upper Right Quadrant



NOT VALID FOR SCANNING

ISBT 128 – Blood type



W2053 11 702452 Ⓞ X

The American National Red Cross
Washington, DC 20006
FDA Registration Number 1173011
US License Number 0190

Properly Identify Intended Recipient
See Circular of Information for indications,
contraindications, cautions and methods of infusion.
This product may transmit infectious agents.
Rx only
VOLUNTEER DONOR

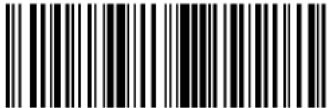

E0378V00



2800



Rh NEGATIVE



0113472359
13 DEC 2011

Expiration
Date/Time

RED BLOOD CELLS
ADENINE-SALINE (AS-3) ADDED
IRRADIATED

From 500 mL CP2D Whole Blood
Store at 1 to 6 C



W2053 11 702463 Ⓞ R

The American National Red Cross
Washington, DC 20006
FDA Registration Number 1173011
US License Number 0190

Properly Identify Intended Recipient
See Circular of Information for indications,
contraindications, cautions and methods of infusion.
This product may transmit infectious agents.
Rx only
VOLUNTEER DONOR



E3045V00



2800



Rh NEGATIVE



0113242359
20 NOV 2011

Expiration
Date/Time

APHERESIS
PLATELETS
IRRADIATED

194 mL
containing approx _____ mL ACD-A

Store at 20 to 24 C

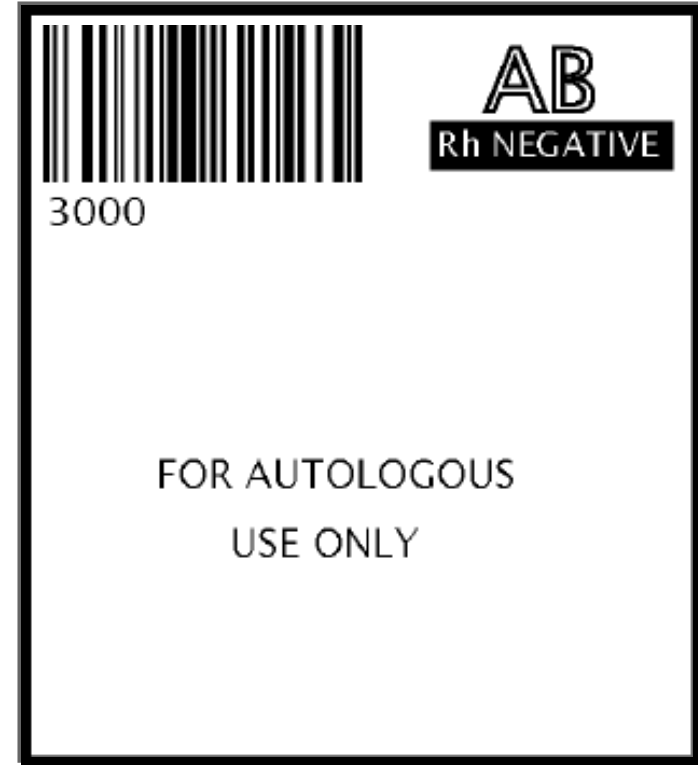

NOT VALID FOR SCANNING

ISBT 128 – Blood type



NOT VALID FOR SCANNING

ISBT 128 – New Product Code

W2053 11 702445 Ⓢ 

5100

The American National Red Cross
Washington, DC 20006
FDA Registration Number 1173011
US License Number 0190

Properly Identify Intended Recipient
See Circular of Information for indications,
contraindications, cautions and methods of infusion.
This product may transmit infectious agents.
Rx only

O

Rh POSITIVE

VOLUNTEER DONOR



E0212V00



0113542359
20 DEC 2011

Expiration Date/Time

RED BLOOD CELLS

From 500 mL CPDA-1 Whole Blood
Store at 1 to 6 C

W2053 11 702453 Ⓢ 

5100

The American National Red Cross
Washington, DC 20006
FDA Registration Number 1173011
US License Number 0190

Properly Identify Intended Recipient
See Circular of Information for indications,
contraindications, cautions and methods of infusion.
This product may transmit infectious agents.
Rx Only

O

Rh POSITIVE

VOLUNTEER DONOR

E0224V00

0113472359
13 DEC 2011

Expiration Date/Time

RED BLOOD CELLS
IRRADIATED
LEUKOCYTES REDUCED

From 500 mL CPDA-1 Whole Blood
Store at 1 to 6 C

NOT VALID FOR SCANNING

Expiration Date/time

- 10 characters
- cyyjjhhmm
 - c = designates century
 - yy = year of expiration
 - jjj = is the Julian date (the number of the day in the year) 031 is January 31st. 186 is July 4th.
 - hh = hour (00-23)
 - mm = minutes (00-59)



0102162359

04 AUG 2010

Expiration
Date/Time

Division Code

- 00-means a unit has not been divided
- A0, B0, C0, D0, E0....Are divide codes for a first level divide
 - If an A0, B0....unit is divided again then it is a secondary level division and indicated by divide codes Aa, Ab, Ac...
- Can only perform two levels of division!
- On each level of division, a product can be divided up to 26 times.

The product volume will print on:

RBC's and SDP's collected via automated apheresis technology

All plasma and cryo from whole blood

Pooled cryo and platelets from whole blood

Low volume autologous whole blood and RBC's

Divided (aliquot) components

All above get weighed on a scale, weight transferred to eP and eP prints the volume on the label.

ISBT 128 ABO Rh Codes:

ABO/Rh Blood Groups	Default: Intended Use Not Specified	Directed Only (Dedicated/ Designated/ Donation)	For Emergency Use Only	Directed Only (Dedicated/ Designated/ Donation) Biohazard	For Autologous Use Only	For Autologous Use Only/ Biohazard
	n	(n-4)	(n-3)	(n-2)	(n+2)	(n+3)
O Rh(D) negative	95	91	92	93	97	98
O Rh(D) positive	51	47	48	49	53	54
A Rh(D) negative	06	02	03	04	08	09
A Rh(D) positive	62	58	59	60	64	65
B Rh(D) negative	17	13	14	15	19	20
B Rh(D) Positive	73	69	70	71	75	76
AB Rh(D) negative	28	24	25	26	30	31
AB Rh(D) positive	84	80	81	82	86	87
O	55	P2	P3	P4	P8	P9
A	66	A2	A3	A4	A8	A9
B	77	B2	B3	B4	B8	B9
AB	88	C2	C3	C4	C8	C9

Divide Scenarios

Regular unit divided on first and second level

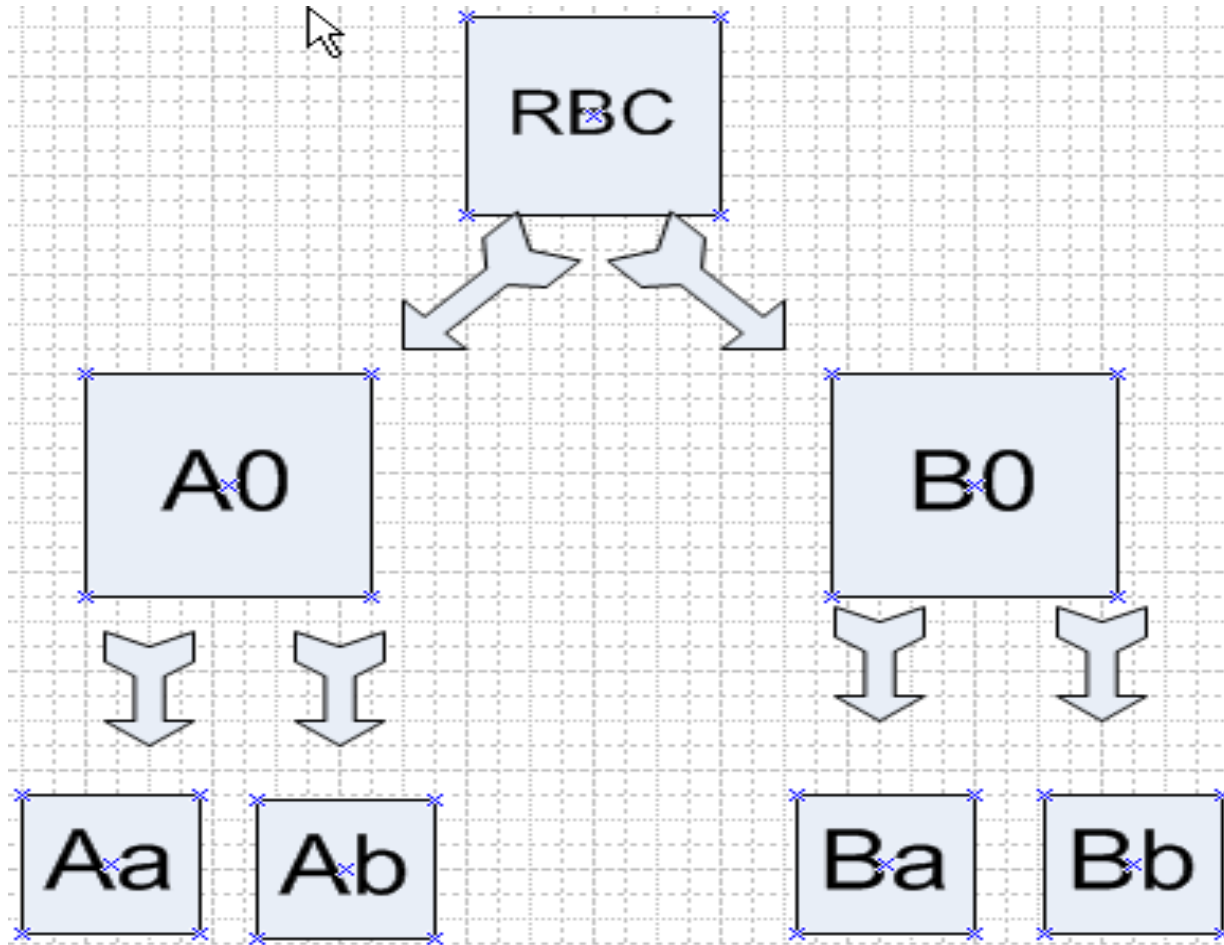

Pedi Pack Creation

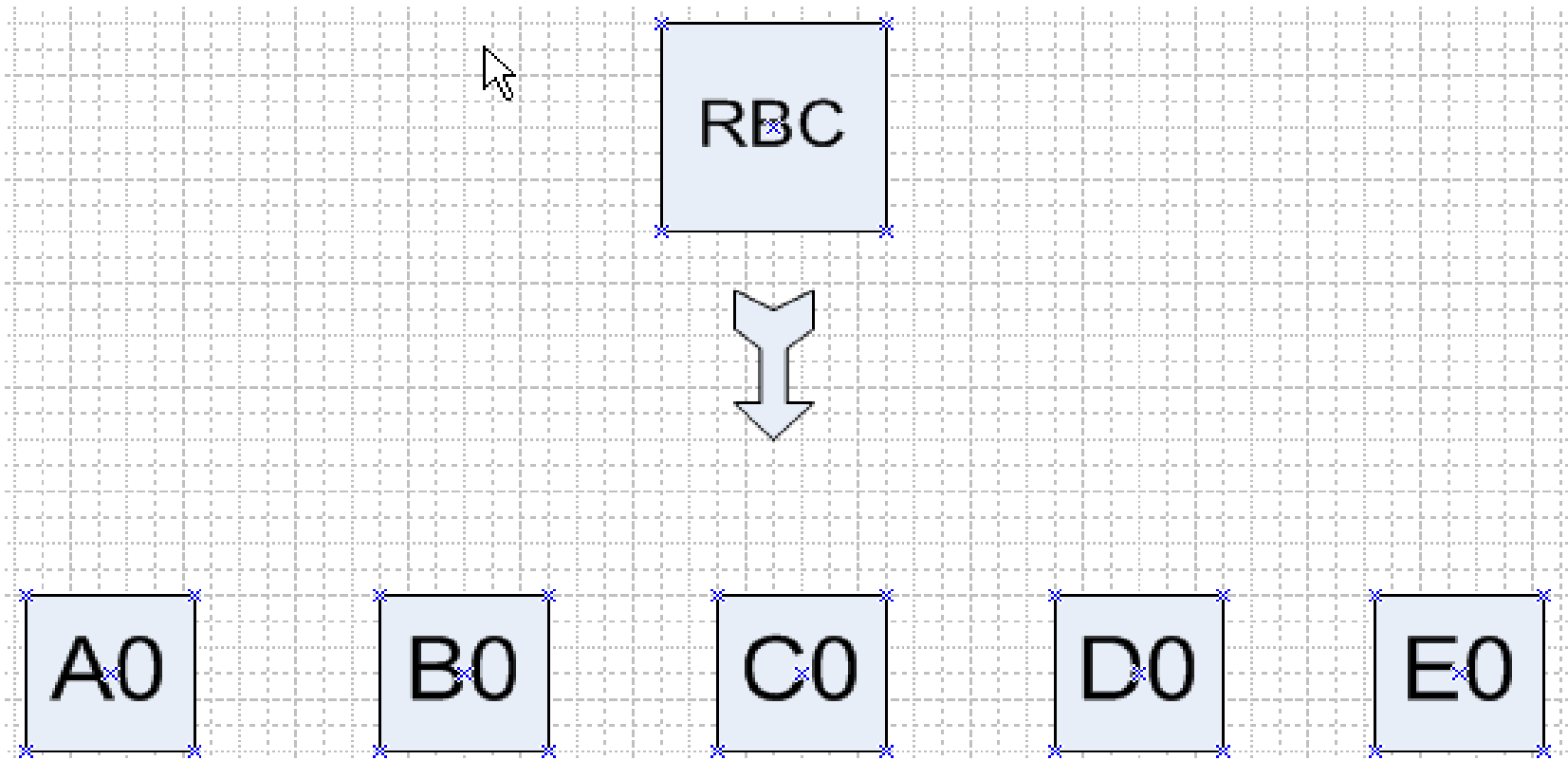

ISBT 128 – DIN Labels Sets

- Initial DIN Label Set provided at collection (See illustration)
- Comes from Computype (No On-Demand Printing)
- Includes a large product DIN, small peel-off for paperwork, and test tube DIN
- Only manufacturing, QC, and the IRL's will have On-Demand Printing capabilities (to re-label a whole blood to a red cell for example)



Sample Product Label (Not FDA Approved)



W2053 11 702449 8 N



9500

The American National Red Cross
Washington, DC 20006
FDA Registration Number 1173011
US License Number 0190

Properly Identify Intended Recipient
See Circular of Information for indications,
contraindications, cautions and methods of infusion.
This product may transmit infectious agents.

Rx only
VOLUNTEER DONOR

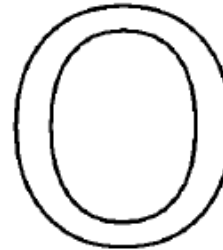

Rh NEGATIVE



E5079V00



0213162359
12 NOV 2021

Expiration
Date/Time

**FROZEN
RED BLOOD CELLS**

283 mL
Store at -65 C or colder

NOT VALID FOR SCANNING



Sample Product Label (Not FDA Approved)



W2053 11 702455 Ⓞ R



6200

The American National Red Cross
Washington, DC 20006
FDA Registration Number 1173011
US License Number 0190

Properly Identify Intended Recipient
See Circular of Information for indications,
contraindications, cautions and methods of infusion.
This product may transmit infectious agents.

Rx Only
VOLUNTEER DONOR

A

Rh POSITIVE



E4531V00



Expiration
Date/Time

0113612359
27 DEC 2011

APHERESIS
RED BLOOD CELLS
ADENINE-SALINE (AS-1) ADDED
LEUKOCYTES REDUCED

283 mL
containing approx 5 mL ACD-A
Store at 1 to 6 C

NOT VALID FOR SCANNING



Sample Product Label (Not FDA Approved)



W2053 11 702458 S L



8400

The American National Red Cross
Washington, DC 20006
FDA Registration Number 1173011
US License Number 0190

Properly Identify Intended Recipient
See Circular of Information for indications,
contraindications, cautions and methods of infusion.
This product may transmit infectious agents.

Rx only
VOLUNTEER DONOR

AB

Rh POSITIVE

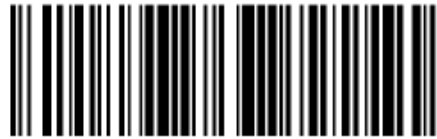

E5165V00



Expiration
Date/Time

0123192359
14 NOV 2012

CRYOPRECIPITATED AHF

Store at -18 C or colder

NOT VALID FOR SCANNING



Sample Product Label (Not FDA Approved)



W2053 11 702450 8 0



0600

The American National Red Cross
Washington, DC 20006
FDA Registration Number 1173011
US License Number 0190

Properly Identify Intended Recipient
See Circular of Information for indications,
contraindications, cautions and methods of infusion.
This product may transmit infectious agents.

Rx only
VOLUNTEER DONOR



Rh NEGATIVE

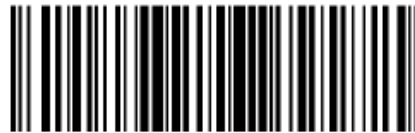

E4520V00



0113202359
16 NOV 2011

Expiration
Date/Time

DEGLYCEROLIZED
RED BLOOD CELLS

283 mL
Store at 1 to 6 C

NOT VALID FOR SCANNING



Sample Product Label (Not FDA Approved)



W2053 11 702457 8 N

The American National Red Cross
Washington, DC 20006
FDA Registration Number 1173011
US License Number 0190

Properly Identify Intended Recipient
See Circular of Information for indications,
contraindications, cautions and methods of infusion.
This product may transmit infectious agents.

Rx only
VOLUNTEER DONOR



E0869V00

APHERESIS
FRESH FROZEN PLASMA
FROZEN WITHIN 6 HOURS
AFTER PHLEBOTOMY

194 mL
containing approx _____ mL ACD-A
Store at -18 C or colder



7300

B

Rh POSITIVE



0123192359
14 NOV 2012

Expiration
Date/Time

NOT VALID FOR SCANNING

