



Automated Hematology Analyzer

XN series

Administrator's Guide

CHAPTER 1	Introduction
CHAPTER 2	Rules Setup
CHAPTER 3	Service/Research data
CHAPTER 4	Instrument Setup
CHAPTER 5	Appendix
	Index

Sysmex Corporation

KOBE, JAPAN

Revision History

10/2010

Initial issue

Software version: 00-00

02/2011

Software version: 00-01

05/2011

Software version: 00-04

02/2012

Software version: 00-08

08/2012

Software version: 00-11

12/2012

Software version: 00-13

08/2013

Software version: 00-15

02/2014

Software version: 00-16

05/2014

Software version: 00-17

02/2015

Software version: 00-19

08/2015

Software version: 00-20

11/2015

Software version: 00-20

01/2016

Software version: Ver.21

11/2016

Software version: Ver.21

03/2017

Software version: Ver.22

09/2017

Software version: Ver.22

Revision History

03/2018

Software version: Ver.22

08/2019

Software version: Ver.22

03/2020

Software version: Ver.22

Changes are listed below:

	Revised section	Page
3.1.2	WNR service data	34
3.1.3	WDF service data	35
3.1.4	RET service data	37
3.1.5	PLT-F service data	38
3.2.1	WBC items for research	45

Table of Contents

Revision History	3
<hr/>	
Chapter 1 Introduction	7
<hr/>	
1.1 Overview of the system	8
1.2 About the manuals	9
1.3 Symbols used in this manual	10
1.4 Trademarks	11
1.5 Prohibited acts	11
1.6 User permissions	11
Chapter 2 Rules Setup	13
<hr/>	
2.1 Types of rules	13
2.2 Rule screen	17
2.3 Enable/Disable rules	24
2.4 Sort rules	25
2.5 Print rules	26
2.6 Save rules	27
2.7 Restore saved rules	28
2.8 Initialize rules	29
Chapter 3 Service/Research data	31
<hr/>	
3.1 Check service data (service)	31
3.2 Check items for research	44
3.3 hsA analysis	48
Chapter 4 Instrument Setup	51
<hr/>	
4.1 Open the settings	51
4.2 Analyzer settings	53
4.3 IPU settings	75
4.4 Graphic printer print settings (GP customize)	108
4.5 Transportation controller settings (CT-90)	117
4.6 RU-20 Reagent Unit Settings	119
Chapter 5 Appendix	125
<hr/>	
5.1 Interface Protocol	125
5.2 Transportation controller connections (CT-90)	125
5.3 ID Barcode specifications	133
5.4 Default settings	141
Index	157
<hr/>	

Chapter 1 Introduction

Thank you for purchasing this automated hematology analyzer.

- This manual explains instrument settings and other routine operations of the hematology analyzer used in clinical laboratories.
- This manual is intended for Key administrators and operators to read, understand and use as reference for proper operations of the instrument.



Note:

Operate the instrument as instructed. Reliability of test results cannot be guaranteed if there are any deviations from the instructions in this manual. If the instrument fails to function properly as a result of either the user's operation not specified in the manual or the user's utilization of a program not specified by Sysmex, the product warranty would not apply.

Contact Addresses



Sysmex Corporation

1-5-1 Wakinojima-Kaigandori, Chuo-ku, Kobe 651-0073, Japan

Authorized Representative/Importer to EU

Europe, Middle East and Africa



Sysmex Europe GmbH

Bornbarch 1, 22848 Norderstedt, Germany

Phone: +49 40 5 27 26-0 / Fax: +49 40 5 27 26-100

Authorized Representatives

Americas

Sysmex America, Inc.

577 Aptakisic Road, Lincolnshire, IL 60069, U.S.A.

Phone: +1-224-543-9500 / Fax: +1-224-543-9505

Asia-Pacific

Sysmex Asia Pacific Pte Ltd.

9 Tampines Grande #06-18 Singapore 528735

Phone: +65-6221-3629 / Fax: +65-6221-3687



The system described in this manual is marked with a CE-mark which confirms the compliance with the essential requirements of the following European Directives:

98/79/EC on in vitro diagnostic medical devices

2011/65/EU on the restriction of the use of certain hazardous substances in electrical and electronic equipment

2014/53/EU relating to the making available on the market of radio equipment

www.sysmex-europe.com/ifu



The system described in this manual is compliant with the European In-Vitro Diagnostic (IVD) Directive and additionally marked with an EAC-mark which confirms the compliance with applicable Technical Regulations of Eurasian Economic Union.

1.1 Overview of the system

Analyzers

Analyzers are classified into 6 types depending on the differences in the included channels.

- XN-10: XN-10[B1], XN-10[B2], XN-10[B3], XN-10[B4]
- XN-20: XN-20[A1], XN-20[A2]

For details on the channels and the analyzer types, see "Instruction For Use."

(▶ Instruction For Use, "Chapter 1: 1.2 Overview of the system")

The analysis data appears on the screen of the IPU (Information Processing Unit)*.

* This manual refers to the Information Processing Unit as IPU.

Configuration description

System expansion is possible by combining components and options. The system name varies depending on the combination. This manual explains the system configuration below .

XN-1000:

System including 1 analyzer (XN-10/XN-20) and a sampler (SA-10/SA-01).

XN-1500:

System including 1 analyzer (XN-10/XN-20), an SP-50 automated hematology slide preparation unit, and a sampler (SA-21).

For an overview of the SP-50, see the SP-50 manual.

XN-2000:

System including 2 analyzers (XN-10/XN-20) and a sampler (SA-20).

XN-3000/XN-3100:

System including 2 analyzers (XN-10/XN-20), an SP-10/SP-50 automated hematology slide preparation unit, and a sampler (SA-30/SA-31).

2 modes are available. In "Standalone mode", the IPU manages SP-10/SP-50 orders. In "Host mode", the SP-10/SP-50 connects directly to the host. Select the mode that best meets the needs of your laboratory. For more information, contact your local dealer or Sysmex Representative.

For an overview of the SP-10/SP-50, see the SP-10/SP-50 manual.

XN-9000/XN-9100:

System including analyzers (XN-10/XN-20), an SP-10/SP-50 automated hematology slide preparation unit and transportation units.

For an overview of the SP-10/SP-50, see the SP-10/SP-50 manual.

1.2 About the manuals

1.2.1 List of manuals

The following manuals are provided with this instrument.

Each manual is bound and included in the product; however, a manual with the same content is also built into the IPU. For procedures on viewing the manual, see "Instruction For Use."

(► Instruction For Use, "Chapter 6: 6.8* On-line manuals")

* 6.9 in the XN-9000/XN-9100 manual.

- **Instructions for Use**

This manual explains how to operate the instrument, focusing primarily on routine work.

- **Administrator's Guide (this manual)**

This manual explains the operations, such as configuration of the instrument.

- **SP-10/SP-50 Instructions for Use***

This section explains how to operate the SP-10/SP-50.

* When using SP-10/SP-50 Automated Hematology Slide Preparation Unit only.

1.2.2 Structure of this manual

This manual consists of the following chapters.

Chapter	Description
Chapter 1: Introduction	Explains this manual and precautions.
Chapter 2: Rules Setup	Explains an overview of rule and setting rules.
Chapter 3: Service/Research data	Explains analysis items, service data and research data.
Chapter 4: Instrument Setup	Explains various function settings of analyzer and IPU, and system setting of transportation controller.
Chapter 5: Appendix	Explains IP message, principles of conveyor, barcode specifications, and default settings.

1.2.3 Points to note about this manual

- You may not reprint the contents of this manual in whole or in part without permission.
- The names of patients, doctors, etc., mentioned in this manual do not represent actual people in any way.
- Images and certain details related to product are for illustration purposes only and may not exactly match with what is indicated within this manual.

1.3 Symbols used in this manual



Risk of infection

Indicates the presence of a biohazardous material or condition.



Warning!

High risk. Ignoring this warning could result in personal injury to the operator.



Caution!

Average risk. Ignoring this warning could result in property damage. To avoid damage and incorrect measuring results.



Information

Minor risk. Considerations that should be observed when operating this instrument.



Note:

Background information and practical tips.



Indicates that the operation supports the touchscreen.

1.4 Trademarks

- Sysmex is a registered trademark of SYSMEX CORPORATION, Japan.
- CELLPACK, CELLCLEAN, Fluorocell, SULFOLYSER, and Lysercell are trademarks of SYSMEX CORPORATION.
- ISBT128 (International Society of Blood Transfusion) is copyrighted by and is used under a license agreement with ICCBBA, Inc.
- Windows is a registered trademark of Microsoft Corporation in the U.S.A., Japan, and other countries.

Other company names and product names in this manual are the trademarks or registered trademarks of their respective owners. The fact that a trademark is not explicitly indicated in this manual does not authorize its use. TM and © are not explicitly indicated in this manual.

1.5 Prohibited acts

- Modification, translation, reverse engineering, decompiling, and disassembly of this manual and the software is prohibited. The creation of derivative works based on this manual or the software is prohibited.
- Copying this manual or the software for purposes other than backup based on the license agreement is prohibited.

1.6 User permissions

The permissions of the logged on user may not allow that user to change settings.

Only the user permitted [All Administrators] or [Modify Settings] can change the setting of the various function.

For the details on user permissions, see Chapter 4.

(►P.83 "Chapter 4: Change settings and add users")

Chapter 2 Rules Setup

This chapter explains the procedures for setting rules to have the analyzer automatically perform a subsequent operation based on the results of the first analysis.

2.1 Types of rules

Rules

Rules can only be displayed and set for the [Built-in User] registered at the factory.

The analysis data are judged by setting rules. The results of judgment can be reviewed in the [Sample Explorer] and [Data Browser] screens. Up to 100 rules can be setup for each condition indicated below*.

A rule-based judgment is performed on the results of the first analysis. A rule-based judgment of the results of the first analysis is performed. Based on the result of the rule-based judgment, [Repeat] analysis, [Rerun] analysis, [Reflex] analysis, comment adding, smear preparation ([SP Rule] judgment), validation, or output is performed. [Repeat], [Rerun], and [Reflex] judgments will be performed for the second analysis results, but not for the third analysis results.

* Registering are possible for [Rerun/Reflex/Comment Rule], [SP Rule], [Validation Rule] or [Output Rule].

Analysis

[Repeat] analysis: Repeats the first analysis.

[Rerun] analysis: Repeats analysis of a sample while holding the results of the first analysis.

[Reflex] analysis: Tests additional parameters due to the results of the first analysis.



Information

If you desire a rule change, registration, deletion or copy, contact Sysmex representative.



Note:

The rules are not applied to the results of analysis for maintenance (QC), analysis of sample number "0", and analysis that resulted in a barcode reader read error.

In the XN series, the following 5 types of rules can be set.

2.1.1 Repeat rule

[Repeat] means to do [Repeat] analysis if an error occurs in the first analysis*.

If an error occurs in the first analysis, a [Repeat] analysis is performed automatically. A [Repeat] rule is set for each error message. The settings can be checked in the rule setting area of the [Repeat Rule] screen.

(►P.19 "Repeat Rule")

[Repeat] judgment is only performed when the analyzer setting is ON. For the details, see Chapter 4.

(►P.64 "Chapter 4: Repeat setting")

* When a sampler (SA-01) is used, analysis is not performed. Only rule judgment is performed.

e.g.	Error message:	[0.25 MPa pressure error]
	Action:	[Repeat]
	Explanation:	If a [0.25 MPa pressure error] occurs, a [Repeat] analysis is automatically performed.

For a list of error messages, refer to the "Instruction For Use".

(►Instruction For Use, "Chapter 14: 14.2 Error message list")

* The error messages below are [BlockRepeat (Fixed)], and are not displayed in the screen.

- [41°C reagent heater thermistor error]
- [34°C reagent heater thermistor error]
- [41°C FCM reaction chamber thermistor error]
- [34°C FCM reaction chamber thermistor error]
- [FCM detector thermistor error]
- [FCM sheath thermistor error]
- [Environment temperature thermistor error]
- [APD thermistor error]
- [Laser output error]

2.1.2 Rerun/Reflex/Comment rule

The result of the first analysis is judged, and a [Rerun] analysis, [Reflex] analysis, or addition of a comment is automatically performed. You can set the judgment conditions for [Rerun] analysis, [Reflex] analysis, and comments. [Rerun/Reflex/Comment Rule] do not function if an error occurs in the first analysis.

[Rerun] judgment and [Reflex] judgment are only performed when the analyzer setting is ON. For the details, see Chapter 4.

(►P.64 "Chapter 4: Rerun/Reflex setting")

Rerun

[Rerun] is used to judge the analysis result and automatically rerun the test*.

The result of the first analysis is judged, and a [Rerun] analysis is automatically performed. When there are multiple analyzers, you can specify which analyzer is used to perform [Rerun] analysis. However, if the specified analyzer does not have the [Rerun] analysis function, [Rerun] analysis is performed using the same analyzer as the initial analysis. You can set the judgment condition under which a [Rerun] analysis is performed.

* When a sampler (SA-01) is used, analysis is not performed. Only rule judgment is performed.

e.g.	Conditional Expression:	[IPMessage]([RBC Abn Distribution])[OR][IPMessage]([Dimorphic Population])
	Action:	[Rerun]([SameModule])
	Explanation:	If the judgment displays an IP message [RBC Abn Distribution] (RBC abnormal distribution) or [Dimorphic Population], [Rerun] analysis is performed automatically using the same analyzer as the initial analysis.

Reflex

[Reflex] is a setting that is used to judge analysis results and automatically perform analysis with additional discrete items not analyzed in the initial analysis*.

The result from the first analysis is judged, and a [Reflex] analysis is performed to generate the additional parameters that are different from the first test. You can set the judgment conditions for performing a [Reflex] analysis of the initial analysis.

* When a sampler (SA-01) is used, analysis is not performed. Only rule judgment is performed.

e.g.	Conditional Expression:	[IPMessage]([PLT Abn Distribution])
	Action:	[Reflex]([DIFF+RET+PLT-F+WPC])
	Explanation:	If the judgment shows the IP message [PLT Abn Distribution](abnormal platelet distribution), a [Reflex] analysis is performed on discrete parameters [DIFF+RET+PLT-F+WPC].

Comment

A comment is a setting that judges the analysis result and automatically displays a comment.

If [None] is selected for the action, a conditional expression that only sets a comment can be set.

e.g.	Conditional Expression:	[ItemValue](HGB[***.* g/dL]) < 8.0
	Action:	[None]
	Comment:	Contact doctor
	Explanation:	When HGB is less than 8.0 g/dL, "Contact doctor" appears in the comment column.

2.1.3 SP Rule

[SP Rule] only appears when the XN-1500 or XN-3000/XN-3100 (Standalone mode) is used. May not appear, depending on the instrument settings.

[SP Rule] judgment is a setting that judges the analysis result and automatically registers a smear order in the [Work List] screen.

Analysis results judged using the [Repeat Rule] or the [Rerun/Reflex/Comment Rule] are judged using the [SP Rule], and smear orders are automatically registered in the [Work List] screen. You can specify the number of slides prepared and the slide glass hopper/cassette, additionally slides can be delivered to the DIA. On the XN-1500 or XN-3100 (Standalone mode), you can specify the smearing conditions used for preparing slides, the number of slides prepared, and the number of additional cleanings performed after sample aspiration. You can also set an alarm to sound when slide preparation is completed.

[SP Rule] judgment is only performed when the analyzer setting is ON. For details, see Chapter 4.

(►P.73 "Chapter 4: SP Settings")

e.g.	Conditional Expression:	[ResultFlag] ([Negative])
	Action:	[Smear] (2Slide)
	Slide glass specification (1st slide):	[Cassette1]*
	Slide glass specification (2nd slide):	[Cassette2]*
	Explanation:	When the flag judgment for analysis data is [Negative], 2 smears are prepared automatically. The slide glass of [Cassette 1]* is used for the first slide, and the slide glass of [Cassette 2]* is used for the second slide. * For the XN-1500 or XN-3100 (Standalone mode), [Right cassette] or [Left cassette] can be set.

2.1.4 Validation rule

To validate means to approve the output of the analysis data for reporting. The [Validation Rule] sets the judgment condition under which validation is automatically performed.

The analysis result that have been already judged by the [Repeat Rule] or the [Rerun/Reflex/Comment Rule] is judged, and validation is automatically performed.

e.g. Conditional Expression: [ResultFlag]([Negative])
 Action: [Validate]
 Explanation: If an analysis data flag judgment result was Negative based on the [Rerun/Reflex/Comment Rule], validation is performed automatically.

2.1.5 Output rule

The [Output Rule] sets the judgment condition for automatically outputting the analysis result.

Analysis result that has been already validated is judged and automatically output. You can also set the output destination.

e.g. Conditional Expression: [ResultFlag]([Negative])
 Action: [ReportTo]([HC])
 Explanation: If the Positive/Negative judgment is [Negative] the analysis data is automatically output to the host computer.

2.2 Rule screen

Click the [Rule] icon in the menu screen to display the following screen.

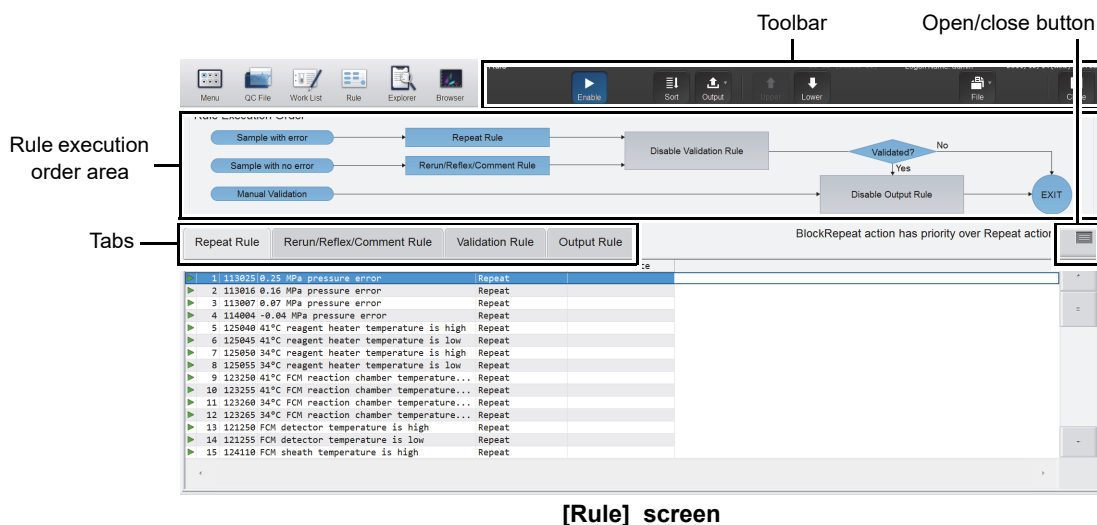

[Rule] screen

Toolbar

The button of the following functions are displayed.

[Enable]*1, 2	Click to enable selected rule(s) in the [Rule] screen. If the rule was already enabled, clicking in the list disable the rule.
[Sort]	Click to display the dialog box for sorting rules in the [Rule] screen.
[Output]	Click to display the submenu for printing displayed rules in ledger format.
[Upper]	Click to move the selection up by 1 row.
[Lower]	Click to move the selection down by 1 row.
[File]	Click to display the submenu for saving, restoring or initializing the rules.
[Close]	Click to close the [Rule] screen.

*1 When [Repeat Rule] is [BlockRepeat(Fixed)], the settings cannot be changed.

*2 The setting of a rule that is valid only can be enabled.

Rule Execution Order

The order of execution of the rules is shown.

Click the open/close button to open/close the Rule Execution Order display area.

[Repeat Rule], [Rerun/Reflex/Comment Rule], [SP Rule]*

If the [Repeat], [Rerun/Reflex] or [Perform Judgement of SP Rule] checkbox is not selected in the analyzer settings, the setting in the rule screen will not be valid. For the details, see Chapter 4.

(►P.64 "Chapter 4: Repeat setting", P.64 "Chapter 4: Rerun/Reflex setting", P.73 "Chapter 4: SP Settings")

* [SP Rule] only appears when the XN-1500 or XN-3000/XN-3100 (Standalone mode) is used. May not appear, depending on the instrument settings.

[Validation Rule], [Output Rule]

The status of the rule appears below the rule name. If the rule in the rule screen is in effect, the status does not appear.

When a rule is set in the IPU settings, [Use Rule ##### Simple Setting] appears. If the rule is OFF, the background is gray and [Rule ##### Disabled] appears.



Validation Rule



Use Simple Validation Rule Settings

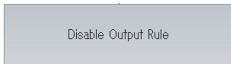

Disable Output Rule

Tabs

Click a tab to change the displayed rule screen list. The [Repeat Rule], [Rerun/Reflex/Comment Rule], [SP Rule], [Validation Rule], and [Output Rule] tabs appear*.

* The tabs that appear vary depending on the instrument that is used.



Note:

You can select multiple data in the sample list as follows:

- Drag multiple consecutive rows
- While pressing Ctrl, click on the row that you want to select

Open/close button

Click to open/close the rule execution order display area.

2.2.1 Rule screens

Repeat Rule

Click the [Repeat Rule] tab to display the following screen*.

* Errors that do not occur due to the instrument configuration are not displayed.

For other errors that are not displayed, see below.

(►P.14 "2.1.1 Repeat rule")

When a sampler (SA-01) is used, the screen below does not appear.

The screenshot shows the 'Repeat Rule' screen with a table of error rules. The table is divided into two main areas: 'Rule setting area' and 'Rule supplementary explanation area'. The table has the following columns: No., Error Message, Action, and Update Date. The 'Action' column contains values like 'Repeat', 'BlockRepeat', and 'None'. A callout box points to the 'BlockRepeat' action, stating 'BlockRepeat action has priority over Repeat action'.

No.	Error Message	Action	Update Date
1	113025 0.25 MPa pressure error	Repeat	
2	113016 0.16 MPa pressure error	Repeat	
3	113007 0.07 MPa pressure error	Repeat	
4	114004 -0.04 MPa pressure error	Repeat	
5	125040 41°C reagent heater temperature is high	Repeat	
6	125045 41°C reagent heater temperature is low	Repeat	
7	125050 34°C reagent heater temperature is high	Repeat	
8	125055 34°C reagent heater temperature is low	Repeat	
9	123250 41°C FCM reaction chamber temperature...	Repeat	
10	123255 41°C FCM reaction chamber temperature...	Repeat	
11	123260 34°C FCM reaction chamber temperature...	Repeat	
12	123265 34°C FCM reaction chamber temperature...	Repeat	
13	121250 FCM detector temperature is high	Repeat	
14	121255 FCM detector temperature is low	Repeat	
15	124110 FCM sheath temperature is high	Repeat	

[Repeat Rule] screen

Rule setting area	Displays whether the rule is ON (▶), OFF (□) or invalid (✗).
[No.]	The unique number assigned to the error for which the [Repeat Rule] is applied is displayed.
[Error Code]	The error code is displayed.
[Error Message]	The error message is displayed.
[Action]	The following actions are displayed.
[None]	[Repeat] is not performed.
[BlockRepeat]	[Repeat] is not performed. Even if other errors occur that have [Repeat] set for the action, if an error occurs that has [BlockRepeat] set, [BlockRepeat] is given priority. [BlockRepeat] disables the [Repeat Rule]. It does not disable [Rerun] or [Reflex].
[Repeat]	[Repeat] is performed.
[BlockRepeat(Fixed)]	Displayed when the action is fixed at [BlockRepeat].
[Update Date]	The date and time the rule was registered or last modified is displayed.
Rule supplementary explanation area	A supplementary explanation of the rule is displayed.



Note:

[Repeat Rule] is applied when an error occurs in the result of the first analysis and when an error occurs in the result of [Rerun], [Reflex]. [Repeat] analysis is not possible for some errors.

Rerun/Reflex/Comment Rule

Click the [Rerun/Reflex/Comment Rule] tab to display the following screen*.

* When the sampler (SA-01) is used, this is displayed as the [Comment Rule] screen.

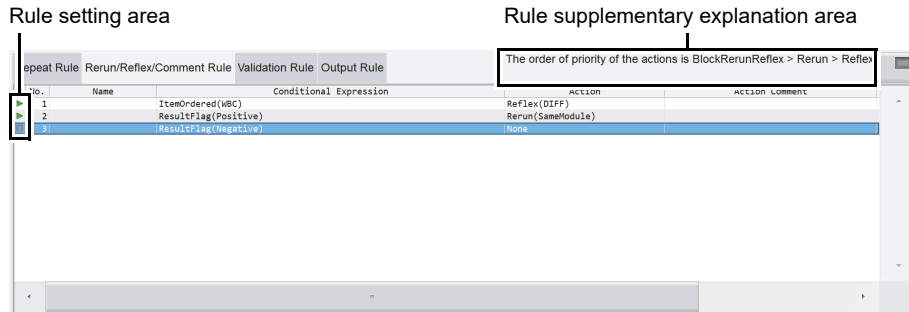

[Rerun/Reflex/Comment Rule] screen

Rule setting area	Displays whether the rule is ON (▶), OFF (◻) or invalid (✗).
[No.]	The rule number appears. If a number greater than "100" (the maximum number that can be registered) is entered, the number will be displayed in red.
[Name]	The name of the rule appears. If not entered, nothing appears.
[Conditional Expression]	Displays the conditional expression for whether [Rerun], [Reflex] is performed.
[Action]	The following actions are displayed.
[None]	[Rerun], [Reflex] is not performed.
[BlockRerunReflex]	[Rerun], [Reflex] is not performed. Even if there are other conditions with [Rerun] or [Reflex] set for the action that are satisfied, if a condition with [BlockRerunReflex] set is satisfied, [BlockRerunReflex] is given priority.
[Rerun]	[Rerun] analysis is performed. If multiple analyzers are used, the analyzer to be used for [Rerun] analysis can be specified.
[Reflex]	[Reflex] analysis is performed. The discrete item of the added channel appears in (). Even when the judgment is [Reflex], if the analysis items belonging to the discrete to be added and all channels were analyzed in the initial analysis, [Reflex] analysis will not be performed.
[QueryToHost]*	The host computer is queried if [Rerun], [Reflex] is necessary.
[Action Comment]	The comment to be added to the analysis data is displayed. Nothing appears if no comments have been entered. The display color varies depending on the importance of the comment.
[Low]	Displays in black characters on a white background.
[Medium]	Displays in black characters on an orange background.
[High]	Displays in white characters on a red background.
[Update Date]	The date and time the rule was registered or last modified is displayed.
[Description]	A description of the rule appears. If not entered, nothing appears.
Rule supplementary explanation area	A supplementary explanation of the rule is displayed.

* Only when IPU service settings are being configured, this will appear.

**Note:**

The result of a [Rerun] or [Reflex] analysis cannot be consolidated with or compared to the result of the first analysis.

SP Rule

Click the [SP Rule] tab to display the following screen.

* [SP Rule] only appears when the XN-1500 or XN-3000/XN-3100 (Standalone mode) is used. May not appear, depending on the instrument settings.

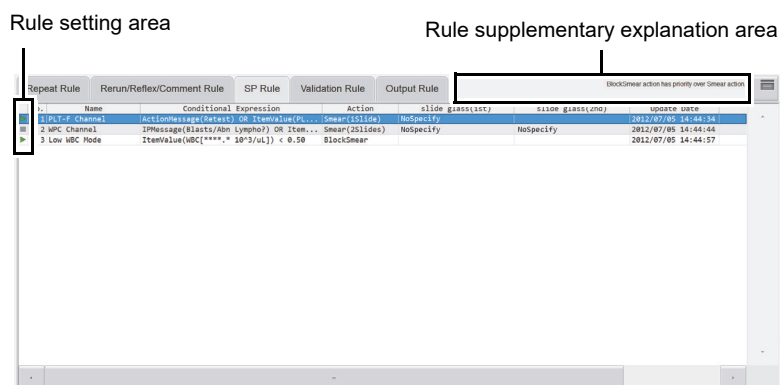

[SP Rule] screen

Rule setting area	Displays whether the rule is ON (▶), OFF (□) or invalid (✗).
[No.]	The rule number appears. If a number greater than "100" (the maximum number that can be registered) is entered, the number will be displayed in red.
[Name]	The name of the rule appears. If not entered, nothing appears.
[Conditional Expression]	Displays the conditional expression for whether validation is performed.
[Action]	The following actions are displayed.
[BlockSmear]	Registration of smear orders (SP rule judgment) is not performed.
[Smear]	Registration of smear orders (SP rule judgment) is performed.
[slide glass (1st)], [slide glass (2nd)]	The slide glass used to prepare the smear can be specified. [NoSpecify], [Cassette1]* ¹ , or [Cassette2]* ¹ appears. If slides are set to be delivered to the DIA, [Deliver to DIA] appears.
[Smearing Condition]*²	Displays the smear conditions to be used for preparing slides.
[Replications]*²	Displays the number of slides prepared from 1 sample.
[Additional Rinse]*²	Displays the number of additional piercer and spreader glass cleanings performed after sample aspiration.
[Alarm]*²	Displays whether an alarm will sound when smear preparation is completed.

[Update Date]	The date and time the rule was registered or last modified is displayed.
[Description]	A description of the rule appears. If not entered, nothing appears.
Rule supplementary explanation area	A supplementary explanation of the rule is displayed.

*1 For the XN-1500 or XN-3100 (Standalone mode), [Right cassette] or [Left cassette] appears.

*2 Only appears when the XN-1500 or XN-3100 (Standalone mode) is used.

Validation Rule

Click the [Validation Rule] tab to display the following screen.

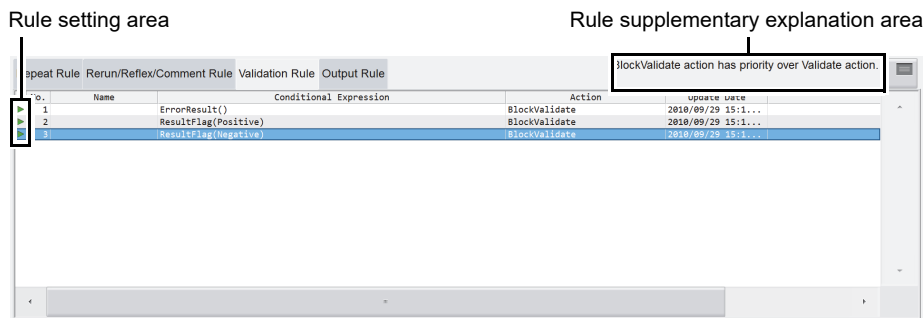

[Validation Rule] screen

Rule setting area	Displays whether the rule is ON (▶), OFF (□) or invalid (✗).
[No.]	The rule number appears. If a number greater than "100" (the maximum number that can be registered) is entered, the number will be displayed in red.
[Name]	The name of the rule appears. If not entered, nothing appears.
[Conditional Expression]	Displays the conditional expression for whether validation is performed.
[Action]	The following actions are displayed.
[BlockValidate]	Validation is not performed. Even if there are other conditions with [Validate] set for the action that are satisfied, if a condition with [BlockValidate] set is satisfied, [BlockValidate] is given priority.
[Validate]	Validation is performed.
[Update Date]	The date and time the rule was registered or last modified is displayed.
[Description]	A description of the rule appears. If not entered, nothing appears.
Rule supplementary explanation area	A supplementary explanation of the rule is displayed.

Output Rule

Click the [Output Rule] tab to display the following screen.

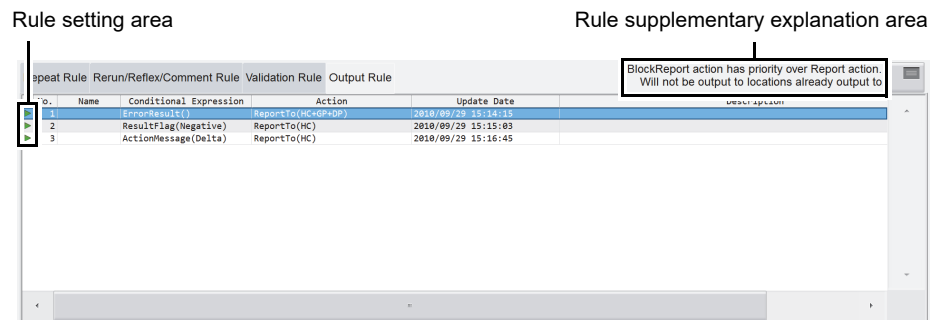

[Output Rule] screen

Rule setting area	Displays whether the rule is ON (▶), OFF (□) or invalid (✖).
[No.]	The rule number appears. If a number greater than "100" (the maximum number that can be registered) is entered, the number will be displayed in red.
[Name]	The name of the rule appears. If not entered, nothing appears.
[Conditional Expression]	Displays the conditional expression for output.
[Action]	The following actions are displayed.
[BlockReport]	Data is not output. Even if there are other conditions with [ReportTo] set for the action that are satisfied, if a condition with [BlockReport] set is satisfied, [BlockReport] is given priority.
[ReportTo]	Data that has been validated is output. The output destination appears in ().
[Update Date]	The date and time the rule was registered or last modified is displayed.
[Description]	A description of the rule appears. If not entered, nothing appears.
Rule supplementary explanation area	A supplementary explanation of the rule is displayed.

2.3 Enable/Disable rules

The enable/disable setting of each rule in the rule screen can be changed*.

* The setting of a rule that is valid only can be changed. The settings of a rule that is fixed to [BlockRepeat] cannot be changed.

Follow the steps below to enable/disable a rule.



1 Click the rule that you wish to enable or disable.

The rule is selected.

You can select multiple orders in the list.

2 Click the [Enable] button on the toolbar.

The rule is enabled/disabled.

When multiple lines of rules are selected, the enable/disable selection of the highlight-selected rule will apply to all selected rules.

For example, when the highlight-selected rule is enabled, all other selected rules are enabled.

2.4 Sort rules

The rules can be sorted in the order of a specified keyword.
 Sorting conditions can be set separately for each tab.
 Follow the steps below to sort the rules.



1 Click the tab of the rules you wish to sort.

2 Click the [Sort] button on the toolbar.

The dialog box on the right appears.

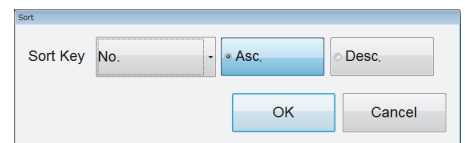

3 Configure the settings that appear.

Sorting conditions can be set by clicking the sort key.

When a keyword is set, the numbers or letters can be sorted in [Asc.] order (0 to 9/A to Z) or [Desc.] order (9 to 0/Z to A).

[No.]	Sort by rule number.
[Name]^{*1}	Sort by rule name.
[Error Code]^{*2}	Sort by error code.
[Error Message]^{*2}	Sort by error message.
[Update Date]	Sort by update date.

*1 [Rerun/Reflex/Comment Rule], [Validation Rule] or [Output Rule] only.

*2 [Repeat Rule] only.

4 Click [OK].

The dialog box will close and the rules will be sorted.

2.5 Print rules

Rules that have been registered can be printed as a list.
Follow the steps below to print rules.

1 Click the tab of the rules that you wish to print.

The rules appear.

2 Click the [Output] - [Ledger (LP)] button on the toolbar.

The displayed rules will be printed as a list.

2.6 Save rules

The various rules that have been registered can be saved to a single file.
Follow the steps below to save the rules.

**Note:**

- As part of good laboratory practices, rules should be saved during initial installation of instrument and any time there are updates or changes to rules.
- Saved file should be stored in a location so it is readily accessible.

1 Click the [File] - [Backup] button on the toolbar.

The [Save As] dialog box appears.

2 Specify or create the folder to save the sample data into.

**Note:**

Even if the simple settings are used for the [Validation Rule] or [Output Rule], any content registered in the rule screen will be saved.

3 Check a file name.

The extension for a file is ".rule".

**Note:**

The default file name is "[XN][Software version][Rule][Date of save_Time of save].rule".
e.g.: [XN][00-01][Rule][20100505_080808].rule

4 Click [Save].

All registered rules are saved.

2.7 Restore saved rules

Saved rules can be restored.

Follow the steps below to restore saved rules.

1 Click the [File] - [Restore] button on the toolbar.

The dialog box on the right appears.

* The rules that appear vary depending on the instrument that is used.

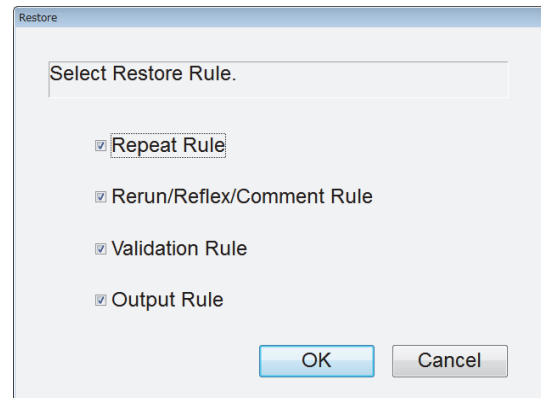

2 Select the checkboxes of the rules that you wish to restore.

3 Click [OK].

The [Open] dialog box appears.

4 Select the file that you wish to restore.

The extension for a file is "rule".

5 Click [Open].

The dialog box on the right appears.

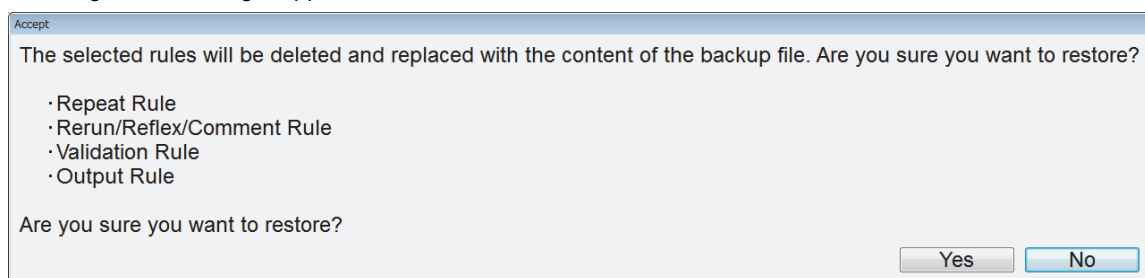

6 Click [Yes].

The rules are restored.



Note:

Rule sorting settings and simple settings are retained even when rules are restored.

2.8 Initialize rules

Rules that have been set can be initialized.
Follow the steps below to initialize rules.

1 Click the [File] - [Initialize] button on the toolbar.

The dialog box on the right appears.

* The rules that appear vary depending on the instrument that is used.

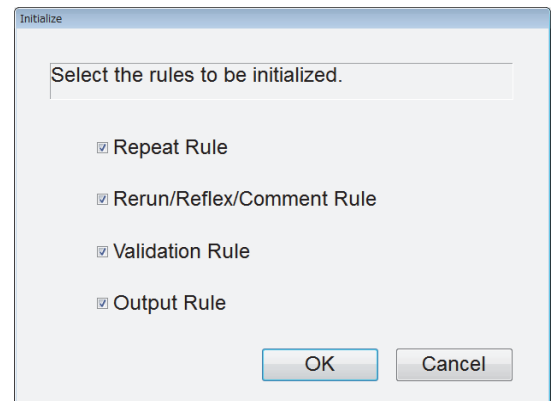

2 Select the checkboxes of the rules that you wish to initialize.

3 Click [OK].

An initialization confirmation dialog box appears.

4 Click [Yes].

The rules are initialized.



Note:

Rule sorting settings and simple settings are retained even when the rules are initialized.

Chapter 3 Service/Research data

This chapter explains service and research data.

3.1 Check service data (service)

The service data of the sample selected in the list in the [Sample Explorer] screen can be checked on the [Service] tab of the [Data Browser] screen*.

* Even when the data is masked in other confirmation screens, the value is displayed. When analysis is not performed on the channel for which the displayed item is calculated, the data is not displayed.

Information

Data displayed on the Service screen is for the purpose of monitoring the status of the instrument. These data must not be used for diagnosis of patients.



Click the [Service] tab in the [Data Browser] to display the following screen.

Main	Graph	Cumulative	Q-Flag	Service	User	Lab. Only	Manual XN-2000-1-L
RBC/PLT	Service Data						
WNR	Sampling Data						
WDF	Reference Data						
RET	Discri						
PLT-F	HGB						
WPC	Distribution						
HARDWARE	RBC						
ADJUSTMENT	Clog						
	Bubble						

Service data display selection area

Service data display selection area Click to display the respective service data. [RBC/PLT], [WNR], [WDF], [RET]*, [PLT-F]*, [WPC]*, [HARDWARE] or [ADJUSTMENT] can be selected.

* These items do not appear with all analyzer types.

3.1.1 RBC/PLT service data



Click [RBC/PLT] to display the following screen.

Main	Graph	Cumulative	Q-Flag	Service	User	Lab. Only	Manual XN-2000-1-L
RBC/PLT	Service Data						
WNR	Sampling Data		Reference Data		Distribution		
	RBC	PLT	R-MFV	P-MFV	RBC		
	889	483	99.2 fL	9.0 fL	RBC		
	916	387	S-RBC 0.00 10 ⁶ /uL	L-RBC 0.00 10 ⁶ /uL	PLT		
	920	384	S-MCV 0.0 fL	L-MCV 0.0 fL			
WDF	912	416	PLT-I 266 10 ³ /uL				
	957	422					
RET	947	386	Discri				
	915	392	RBC-LD 8	PLT-LD 1			
PLT-F	946	416	RBC-HD				
	951	393	RBC-UD 49	PLT-UD 25			
	479	187	HGB				
WPC	0	0	14.3 g/dL	Sample 6690			
	0	0	8.9 mmol/L	Blank 5260			
HARDWARE	0	0	8.88 mmol/L				
	0	0					
ADJUSTMENT	8836 (*8)	3786 (*1)					

● [Sampling Data]

This sampling data can indicate the occurrence of disturbing background noise. If the difference between the maximum value and the minimum value constitute a proportion of the total sampling value that exceeds the specified range, a sampling error will occur.

- The count of the RBC/PLT channel measured at fixed intervals appears in the column below [RBC] and [PLT].
- The data of a maximum of 32 measurements is displayed.
- The total count appears at the bottom of the table.
- The total cell count is calculated by a multiple of the value in the parentheses so that the total particle count falls into the range of 0 to 9999.

● [Reference Data]

[R-MFV]	Most frequently occurring value for the red blood cell volume. (units: fL)
[P-MFV]	Most frequently occurring value for the platelet volume. (units: fL)
[S-RBC]	The RBC count of the smaller red cell distribution out of the 2 peak RBC distributions.
[L-RBC]	The RBC count of the larger red cell distribution out of the 2 peak RBC distributions.
[S-MCV]	MCV of the smaller red cell distribution out of the 2 peak distributions.
[L-MCV]	MCV of the larger red cell distribution out of the 2 peak distributions.
[PLT-I]	The PLT count calculated from the RBC/PLT channel (PLT distributions).

- **[Discr]**

[RBC-LD]	The position of the lower limit discriminator of the RBC distribution (Numerical value from 0 to 49 with 49 full scale.).
[RBC-MD]	The position of the discriminator that separates the 2 peak RBC distribution into a distribution with a lower limit MCV and a distribution with a higher limit MCV (Numerical value from 0 to 49 with 49 full scale.).
[RBC-UD]	The position of the higher limit discriminator of the RBC distribution (Numerical value from 0 to 49 with 49 full scale.).
[PLT-LD]	The position of the lower limit discriminator of the PLT distribution (Numerical value from 0 to 39 with 39 full scale.).
[PLT-UD]	The position of the higher limit discriminator of the PLT distribution (Numerical value from 0 to 39 with 39 full scale.).

- **[HGB]**

Hemoglobin values appear in 3 formats in the left column.

[Sample]	Optical density of the sample converted by A/D conversion.
[Blank]	Optical density of a blank sample converted by A/D conversion.

- **[Distribution]**

[RBC]	If the RBC distribution is abnormal, abnormal distribution information will be displayed.
[PLT]	If the PLT distribution is abnormal, abnormal distribution information will be displayed.

- **[RBC]**

[Clog]	Electronically detected numerical value indicating the amount of clogging in the RBC detector.
[Bubble]	Electronically detected numerical value indicating the amount of air bubbles in the RBC detector.

3.1.2 WNR service data



Click [WNR] to display the following screen.

Main		Graph	Cumulative	Q-Flag	Service	User	Lab. Only	Manual XN-2009-1-L
RBC/PLT	Service Data							
WNR	Sampling Data		Scattergram Sensitivity					
WDF	WNR	582	WNR-X	151.2	ch	WNR-WX	426	
RET	631	0	WNR-Y	103.4	ch	WNR-WY	673	
PLT-F	590	0	NRBC-X	84.0	ch			
WPC	656	0	NRBC-Y	127.0	ch			
HARDWARE	569	0	Reference Data					
ADJUSTMENT	656	0	WBC-N	4,521	10 ⁹ /uL			
	600	0	TNC-N	4,522	10 ⁹ /uL			
	584	0	Cell 1	5386				
	538	0	Laser Current					
	5386	(*1)	LD driver	58.14	mA			

● [Sampling Data]

This sampling data can indicate the occurrence of disturbing background noise. If the difference between the maximum value and the minimum value constitute a proportion of the total sampling value that exceeds the specified range, a sampling error will occur.

- The count of the WNR channel measured at fixed intervals appears in the column below [WNR].
- The data of a maximum of 16 measurements is displayed.
- The total count appears at the bottom of the table.
- The total cell count is calculated by a multiple of the value in the parentheses so that the total particle count falls into the range of 0 to 9999.

● [Scattergram Sensitivity]

[WNR-X]	The fluorescent light intensity of the WBC area on the WNR scattergram.
[WNR-Y]	The forward scattered light intensity of the WBC area on the WNR scattergram.
[WNR-WX]	The fluorescent light distribution width index of the WBC area on the WNR scattergram.
[WNR-WY]	The forward scattered light distribution width index of the WBC area on the WNR scattergram.
[NRBC-X]	The fluorescent light intensity of the NRBC area on the WNR scattergram.
[NRBC-Y]	The forward-scattered light intensity of the NRBC area on the WNR scattergram.

● [Reference Data]

[WBC-N]	The WBC count calculated from the WNR channel.
[TNC-N]	The total nucleated cell count(WBC+NRBC) calculated from the WNR channel.
[iRBC-WNR#]*	The iRBC count calculated from the WNR channel.
[Cell 1]	Total count measured in the WNR channel.

* The availability of this function depends on your system configuration.

● [Laser Current]

[LD driver]	The current of the LD driver.
-------------	-------------------------------

3.1.3 WDF service data



Click [WDF] to display the following screen.

Main	Graph	Cumulative	Q-Flag	Service	User	Lab. Only	Manual XN-2000-1-L
RBC/PLT	Service Data						
WNR	Sampling Data						
WDF	WDF	741	749	865	0	760	0
RET	818	0	793	0	810	0	796
PLT-F	774	0	7046	(*1)			
WPC	Scattergram Sensitivity						
HARDWARE	WDF-X	153.6	ch	WDF-WX	462		
ADJUSTMENT	WDF-Y	46.2	ch	WDF-WY	1142		
	NE-SSC	153.6	ch	LY-X	80.5	ch	
	NE-SFL	46.2	ch	LY-Y	62.8	ch	
	WBC-FX	0.0	ch				
	Reference Data						
	WBC-D	5.683	10 ³ /uL	DLT-HBCD	[WBC-D/WBC]	0.97	
	TNC-D	5.683	10 ³ /uL	Cell 1	7046	Cell 2	5277
	Laser Current						
	LD driver	60.59	mA				

● [Sampling Data]

This sampling data can indicate the occurrence of disturbing background noise. If the difference between the maximum value and the minimum value constitute a proportion of the total sampling value that exceeds the specified range, a sampling error will occur.

- The count of the WDF channel measured at fixed intervals appears in the column below [WDF].
- The data of a maximum of 16 measurements is displayed.
- The total count appears at the bottom of the table.
- The total cell count is calculated by a multiple of the value in the parentheses so that the total particle count falls into the range of 0 to 9999.
- In the case of analysis data of [hsA] mode, 2 cycles of data appear.
- * The availability of this function depends on your system configuration.

● [Scattergram Sensitivity]

[WDF-X]	The lateral scattered light intensity of the WBC area on the WDF scattergram.
[WDF-Y]	The fluorescent light intensity of the WBC area on the WDF scattergram.
[WDF-WX]	The lateral scattered light distribution width index of the WBC area on the WDF scattergram.
[WDF-WY]	The fluorescent light distribution width index of the WBC area on the WDF scattergram.
[NE-SSC]	The lateral scattered light intensity of the NEUT area on the WDF scattergram.
[NE-SFL]	The fluorescent light intensity of the NEUT area on the WDF scattergram.
[LY-X]	The lateral scattered light intensity of the LYMPH area on the WDF scattergram.
[LY-Y]	The fluorescent light intensity of the LYMPH area on the WDF scattergram.
[WBC-FX]	The WBC(FSC) distribution average value of the WBC area.

● [Reference Data]

[WBC-D]	The WBC count calculated from the WDF channel.
[DLT-WBCD [WBC-D/WBC-N]]	The ratio of the white blood cell count (WBC-N) calculated from the WNR channel by the white blood cell count (WBC-D) calculated from the WDF channel.
[TNC-D]	The total nucleated cell count (WBC count + nucleated RBC count) calculated from the WDF channel.
[iRBC-WDF#]*	The iRBC count calculated from the WDF channel.
[Cell 1]	Total count calculated from the WDF channel.
[Cell 2]	Count plotted in the WDF scattergram.

* The availability of this function depends on your system configuration.

● [Laser Current]

[LD driver]	The current of the LD driver.
-------------	-------------------------------

3.1.4 RET service data



Click [RET]* to display the following screen.

* This screen does not appear with all analyzer types.

Service Data				
Sampling Data				
RET	RET-RBC-X	28.3 ch	RET-RBC-WX	593
1719 0	RET-RBC-Y	175.8 ch	RET-RBC-WY	210
1717 0	RET-X	56.0 ch		
1666 0	RET-Y	184.9 ch		
1696 0				
1638 0				
1323 0				
0 0				
0 0				
9752				
(+7)				
Scattergram Sensitivity				
	RBC-O	4.88 10 ⁶ /uL	PLT-O	239 10 ³ /uL
	DLT-RBC	1.00	DLT-PLTO	0.94
	[RBC-O/RBC-I]		[PLT-O/PLT-I]	
	Unclassified	1	Cell Total	68265
Reference Data				
Laser Current				
	LD driver	64.26 mA		

● [Sampling Data]

This sampling data can indicate the occurrence of disturbing background noise. If the difference between the maximum value and the minimum value constitute a proportion of the total sampling value that exceeds the specified range, a sampling error will occur.

- The count of the RET channel measured at fixed intervals appears in the column below [RET].
- The data of a maximum of 16 measurements is displayed.
- The total count appears at the bottom of the table.
- The total cell count is calculated by a multiple of the value in the parentheses so that the total particle count falls into the range of 0 to 9999.

● [Scattergram Sensitivity]

[RET-RBC-X]	The fluorescent light intensity of RBC (mature red blood cells) area on the RET scattergram.
[RET-RBC-Y]	The forward scattered light intensity of RBC (mature red blood cells) area on the RET scattergram.
[RET-RBC-WX]	The fluorescent light distribution width index of RBC (mature red blood cells) area on the RET scattergram.
[RET-RBC-WY]	The forward scattered light distribution width index of the RBC (mature red blood cell) area of the RET scattergram.
[RET-X]	The fluorescent light intensity of the RET area on the RET scattergram.
[RET-Y]	The forward scattered light intensity of the RET area on the RET scattergram.

● [Reference Data]

[RBC-O]	RBC count calculated from the RET channel.
[PLT-O]	PLT count calculated from the RET channel.
[DLT-RBC [RBC-O/RBC]]	The ratio of the RBC count(RBC-O) in the RET channel to the RBC count(RBC) in the RBC/PLT channel (RBC distribution).
[DLT-PLTO [PLT-O/PLT-I]]	The ratio of the platelet count(PLT-O) in the RET channel to the platelet count(PLT-I) in the RBC/PLT channel (PLT distribution).
[Unclassified]	Count appearing in the area of the low value of the forward scattered light signal and the high value of side fluorescent light on the RET scattergram.
[Cell Total]	Total count measured in the RET channel.

● [Laser Current]

[LD driver]	The current of the LD driver.
-------------	-------------------------------

3.1.5 PLT-F service data



Click [PLT-F]* to display the following screen.

* This screen does not appear with all analyzer types.

Main	Graph	Cumulative	Q-Flag	Service	User	Lab. Only	Manual XN-2000-1-L																																																						
RBC/PLT	Service Data																																																												
WVR	Sampling Data																																																												
WDF	<table border="1"> <tr> <td>PLT-F</td> <td>3142</td> <td>PLT-F-RBC-X</td> <td>72.6 ch</td> <td>PLT-F-RBC-WX</td> <td>730</td> </tr> <tr> <td>690</td> <td>0</td> <td>PLT-F-RBC-Y</td> <td>237.8 ch</td> <td>PLT-F-RBC-WY</td> <td>84</td> </tr> <tr> <td>633</td> <td>0</td> <td>PLT-F-X</td> <td>80.4 ch</td> <td></td> <td></td> </tr> <tr> <td>588</td> <td>0</td> <td>PLT-F-Y</td> <td>61.5 ch</td> <td></td> <td></td> </tr> <tr> <td>633</td> <td>0</td> <td></td> <td></td> <td></td> <td></td> </tr> <tr> <td>632</td> <td>0</td> <td></td> <td></td> <td></td> <td></td> </tr> <tr> <td>686</td> <td>0</td> <td></td> <td></td> <td></td> <td></td> </tr> <tr> <td>656</td> <td>0</td> <td></td> <td></td> <td></td> <td></td> </tr> <tr> <td>682</td> <td>0</td> <td></td> <td></td> <td></td> <td></td> </tr> </table>							PLT-F	3142	PLT-F-RBC-X	72.6 ch	PLT-F-RBC-WX	730	690	0	PLT-F-RBC-Y	237.8 ch	PLT-F-RBC-WY	84	633	0	PLT-F-X	80.4 ch			588	0	PLT-F-Y	61.5 ch			633	0					632	0					686	0					656	0					682	0				
PLT-F	3142	PLT-F-RBC-X	72.6 ch	PLT-F-RBC-WX	730																																																								
690	0	PLT-F-RBC-Y	237.8 ch	PLT-F-RBC-WY	84																																																								
633	0	PLT-F-X	80.4 ch																																																										
588	0	PLT-F-Y	61.5 ch																																																										
633	0																																																												
632	0																																																												
686	0																																																												
656	0																																																												
682	0																																																												
RET	Reference Data																																																												
PLT-F	8246 (*4)	AREA-F#	25005	DLT-PLT-F [PLT-F/PLT-I]	0.99																																																								
WPC		AREA#	0																																																										
HARDWARE		Cell 1	385212	Cell 2	20539																																																								
ADJUSTMENT		Cell 3	364424	Cell 4	0																																																								
		Laser Current	64.26 mA																																																										
		LD driver																																																											

● [Sampling Data]

This sampling data can indicate the occurrence of disturbing background noise. If the difference between the maximum value and the minimum value constitute a proportion of the total sampling value that exceeds the specified range, a sampling error will occur.

- The count of the PLT-F channel measured at fixed intervals appears in the column below [PLT-F].
- The data of a maximum of 16 measurements is displayed.
- The total count appears at the bottom of the table.
- The total cell count is calculated by a multiple of the value in the parentheses so that the total particle count falls into the range of 0 to 9999.

● [Scattergram Sensitivity]

[PLT-F-RBC-X]	The fluorescent light intensity of the RBC area on the PLT-F scattergram.
[PLT-F-RBC-Y]	The forward scattered light intensity of the RBC area on the PLT-F scattergram.
[PLT-F-RBC-WX]	The fluorescent light distribution width index of the RBC area on the PLT-F scattergram.
[PLT-F-RBC-WY]	The forward scattered light distribution width index of the RBC area on the PLT-F scattergram.
[PLT-F-X]	The fluorescent light intensity of the PLT area on the PLT-F scattergram.
[PLT-F-Y]	The forward scattered light intensity of the PLT area on the PLT-F scattergram.

● [Reference Data]

[AREA-F#]	The count of AREA-F of the PLT-F scattergram.
[DLT-PLT-F [PLT-F/PLT-I]]	The ratio of the platelet count (PLT-F) calculated from the PLT-F channel to the platelet count (PLT-I) calculated from the PLT channel.
[AREA#]	The count of AREA1 of the PLT-F scattergram.
[Cell 1]	Count measured in the PLT-F channel over an interval of 16.1 seconds.
[Cell 2]	Count plotted on the PLT-F scattergram over an interval of 16.1 seconds.
[Cell 3]	Count counted in the PLT-F channel over an interval of 16.1 seconds and having a certain signal intensity.
[Cell 4]	Count counted in the PLT-F channel in the 0.5 second interval after 16.1 seconds and having a certain signal intensity.

● [Laser Current]

[LD driver]	The current of the LD driver.
-------------	-------------------------------

3.1.6 WPC service data



Click [WPC]* to display the following screen.

* This screen does not appear with all analyzer types.

Main	Graph	Cumulative	Q-Flag	Service	User	Lab. Only	Manual XN-2000-1-L
RBC/PLT	Service Data						
WNR	Sampling Data		Scattergram Sensitivity				
WDF	540 564		WPC-X 73.6 ch				
RET	538 0		WPC-Y 167.0 ch				
PLT-F	533 0		Reference Data				
WPC	566 0		WBC-P 5.788 10 ³ /uL DLT-WBCP 0.98				
HARDWARE	572 0		TNC-P 5.788 10 ³ /uL [WBC-P/WBC]				
ADJUSTMENT	530 0		Cell 1 4962 Cell 2 4943				
	554 0		AREA1# 14 AREA2# 7				
	565 0		AREA3# 9				
	4962 (*1)		Laser Current				
			LD driver 58.14 mA				

● [Sampling Data]

This sampling data can indicate the occurrence of disturbing background noise. If the difference between the maximum value and the minimum value constitute a proportion of the total sampling value that exceeds the specified range, a sampling error will occur.

- The count of the WPC channel measured at fixed intervals appears in the column below [WPC].
- The data of a maximum of 16 measurements is displayed.
- The total count appears at the bottom of the table.
- The total cell count is calculated by a multiple of the value in the parentheses so that the total particle count falls into the range of 0 to 9999.
- In the case of analysis data of [HPC] mode, 4 cycles of sampling data appear*.

* The HPC analysis can only be performed if the instrument offers the HPC analysis mode.

- **[Scattergram Sensitivity]**

[WPC-X]	The lateral scattered light intensity of the WBC area on the WPC scattergram.
[WPC-Y]	The fluorescent light intensity of the WBC area on the WPC scattergram.

- **[Reference Data]**

[WPC-P]	White blood cell count calculated from the WPC channel.
[DLT-WBCP [WBC-P/WBC-N]]	The ratio of the white blood cell count (WBC-P) calculated from the WNR channel by the white blood cell count (WBC-N) calculated from the WPC channel.
[TNC-P]	The total nucleated cell count(WBC+NRBC) calculated from the WPC channel.
[Cell 1]	Total count calculated from the WPC channel.
[Cell 2]	Count plotted in the WPC scattergram.
[AREA1#]	The count in AREA1 on the WPC scattergram.
[AREA2#]	The count in AREA2 on the WPC scattergram.
[AREA3#]	The count in AREA3 on the WPC scattergram.

- **[Laser Current]**

[LD driver]	The current of the LD driver.
-------------	-------------------------------

3.1.7 HARDWARE service data



Click [HARDWARE] to display the following screen.

Main	Graph	Cumulative	Q-Flag	Service	User	Lab. Only	Manual XN-2000-1-L					
RBC/PLT	Service Data											
	Unit Counter											
	Total	0	41°C Liquid Heater	41.9	Pressure							
WNR	Cleaning	0	34°C Liquid Heater	34.3	Timing (Sequence)	1	2	3				
	Piercer	0	41°C FCM Reaction Chamber	41.0	0.25MPa	0.2485	0.2485	----				
WDF	WB Aspiration Motor	0	34°C FCM Reaction Chamber	33.9	0.16MPa	0.1611	0.1603	----				
	FCM Sheath Motor	0	FCM Detector Heater	39.8	0.07MPa	0.0723	0.0723	----				
RET	RBC Sheath Motor	0	FCM Sheath-Temp.	27.9	-0.04MPa	0.0480	0.0493	----				
			APD Temp.	35.5	Aspiration Sensor							
PLT-F			Environment Temp.	27.7	blank	8157	1	18094	2	27164	3	22629
WPC	Laser				RBC/HGB Drain Sensor							
	Oscillate Time	0:00:00			blank	8157	1	0	2	0		
HARDWARE												
ADJUSTMENT												

- **[Unit Counter]**

The operation count of each unit is displayed*.

* [Total] shows the operation count of the overall analyzer. [Piercer] displays the previous operation count after piercer replacement.

- **[Temperature]**

The temperature of each part is displayed*^{1, 2}.

*¹ [Environment Temp.] is the surrounding temperature.

*² [34°C Liquid Heater] and [34°C FCM Reaction Chamber] do not appear with all analyzer types.

- **[Pressure]**

Displays pressure data at any set monitor timing.

- **[Aspiration Sensor]**

In the case of analysis data of [HPC] mode, 2 cycles of data appear.

[blank] Data used for monitoring of blood aspiration is displayed.

[sample] Data used for monitoring of blood aspiration is displayed.

* The HPC analysis can only be performed if the instrument offers the HPC analysis mode.

- **[RBC/HGB Drain Sensor]**

[blank] Data used for monitoring of RBC/HGB analysis sample discharge is displayed.

[sample] Data used for monitoring of RBC/HGB analysis sample discharge is displayed.

- **[Laser]**

The sum of the laser oscillation time appears.

3.1.8 ADJUSTMENT service data

A list of the items used for sensitivity adjustment appears in the [ADJUSTMENT] screen. For items that are the same as in other screens, the same data is displayed.



Click [ADJUSTMENT] to display the following screen*1, 2.

*1 The scattergram is not displayed an enlarged view by double-clicking.

*2 [WPC(SSC-FSC)] does not appear with all analyzer types.

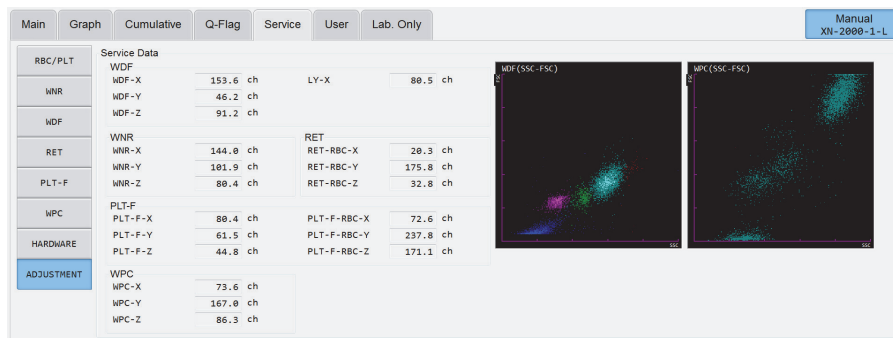

● [WDF]

[WDF-X]	The lateral scattered light intensity of the WBC area on the WDF scattergram.
[WDF-Y]	The fluorescent light intensity of the WBC area on the WDF scattergram.
[WDF-Z]	The forward scattered light intensity of the WBC area on the WDF scattergram.
[LY-X]	The lateral scattered light intensity of the LYMPH area on the WDF scattergram.

● [WNR]

[WNR-X]	The fluorescent light intensity of the WBC area on the WNR scattergram.
[WNR-Y]	The forward scattered light intensity of the WBC area on the WNR scattergram.
[WNR-Z]	The lateral scattered light intensity of the WBC area on the WNR scattergram.

● **[WPC]***

[WPC-X]	The lateral scattered light intensity of the WBC area on the WPC scattergram.
[WPC-Y]	The fluorescent light intensity of the WBC area on the WPC scattergram.
[WPC-Z]	The forward scattered light intensity of the WBC area on the WPC scattergram.

* This area does not appear with all analyzer types.

● **[RET]***

[RET-RBC-X]	The fluorescent light intensity of the RBC (mature red blood cells) on the RET scattergram.
[RET-RBC-Y]	The forward scattered light intensity of the RBC (mature red blood cells) on the RET scattergram.
[RET-RBC-Z]	The lateral scattered light intensity of the RBC (mature red blood cells) on the RET scattergram.

* This area does not appear with all analyzer types.

● **[PLT-F]***

[PLT-F-X]	The fluorescent light intensity of the PLT area on the PLT-F scattergram.
[PLT-F-Y]	The forward scattered light intensity of the PLT area on the PLT-F scattergram.
[PLT-F-Z]	The lateral scattered light intensity of the PLT area on the PLT-F scattergram.
[PLT-F-RBC-X]	The fluorescent light intensity of the RBC area on the PLT-F scattergram.
[PLT-F-RBC-Y]	The forward scattered light intensity of the RBC area on the PLT-F scattergram.
[PLT-F-RBC-Z]	The lateral scattered light intensity of the RBC area on the PLT-F scattergram.

* This area does not appear with all analyzer types.

3.2 Check items for research

Settings can be configured in the [Sample Explorer] or the [Data Browser] to display items for research. Items for research are displayed on a gray background.

For the setting, see "Instruction for Use."

(▶Instruction for Use, "Chapter 10: 10.11 Change layout of analysis data list", "Chapter 11: 11. 6* Change layout of screen")

* 11.4 in the XN-9000/XN-9100 manual.



Information

Analysis results of research parameters are indicated by a gray background to distinguish them from report analysis results. Research items are the parameter for research. Analysis results for these parameters must not be used for diagnosis of patients.

3.2.1 WBC items for research

The WBC items for research below can be set to be displayed.

● Items

TNC	The total nuclear cell count(WBC#+NRBC#).
WBC-N	The WBC count calculated from the WNR channel.
TNC-N	The total nuclear cell count(WBC#+NRBC#) calculated from the WNR channel.
BA-N#	The basophil counts calculated from the WNR channel.
BA-N%	The basophil percent calculated from the WNR channel.
WBC-D	The WBC count calculated from the WDF channel.
TNC-D	The total nuclear cell count(WBC#+NRBC#) calculated from the WDF channel.
NEUT#&	The number of particles obtained by subtracting the IG count from the NEUT count.
NEUT%&	The ratio of the count obtained by subtracting IG# from NEUT# to the WBC count.
LYMP#&	The number of particles obtained by subtracting the HFLC count from the LYMPH count.
LYMP%&	The ratio of the count obtained by subtracting HFLC# from LYMPH# to the WBC count.
HFLC#	The count of the upper LYMPH area of the WDF scattergram.
HFLC%	The ratio of the count of the upper LYMPH area of the WDF scattergram to the WBC count.
AS-LYMP%L*¹	The ratio of the AS-LYMP count to the lymphocyte count.
RE-LYMP%L*¹	The ratio of the RE-LYMP count to the lymphocyte count.
BA-D#	The basophil counts calculated from the WDF channel.
BA-D%	The basophil percent calculated from the WDF channel.
NE-SSC	The lateral scattered light intensity of the NEUT area on the WDF scattergram.
NE-SFL	The fluorescent light intensity of the NEUT area on the WDF scattergram.
NE-FSC	The forward-scattered light intensity of the NEUT area on the WDF scattergram.
LY-X	The lateral scattered light intensity of the LYMPH area on the WDF scattergram.
LY-Y	The fluorescent light intensity of the LYMPH area on the WDF scattergram.
LY-Z	The forward-scattered light intensity of the LYMPH area on the WDF scattergram.

MO-X	The lateral scattered light intensity of the MONO area on the WDF scattergram.
MO-Y	The fluorescent light intensity of the MONO area on the WDF scattergram.
MO-Z	The forward-scattered light intensity of the MONO area on the WDF scattergram.
NE-WX	The lateral scattered light distribution width index of the NEUT area on the WDF scattergram.
NE-WY	The fluorescent light distribution width index of the NEUT area on the WDF scattergram.
NE-WZ	The forward-scattered light distribution width index of the NEUT area on the WDF scattergram.
LY-WX	The lateral scattered light distribution width index of the LYMPH area on the WDF scattergram.
LY-WY	The fluorescent light distribution width index of the LYMPH area on the WDF scattergram.
LY-WZ	The forward-scattered light distribution width index of the LYMPH area on the WDF scattergram.
MO-WX	The lateral scattered light distribution width index of the MONO area on the WDF scattergram.
MO-WY	The fluorescent light distribution width index of the MONO area on the WDF scattergram.
MO-WZ	The forward-scattered light distribution width index of the MONO area on the WDF scattergram.
WBC-P*²	WBC count calculated from WPC channel.
TNC-P*²	The total nuclear cell count(WBC#+NRBC#) calculated from WPC channel.

*1 The availability of these functions depends on your system configuration.

*2 These items do not appear with all analyzer types.

3.2.2 RBC/PLT items for research

The RBC/PLT items for research below can be set to be displayed.

● Items for research

PLT-I	The PLT count calculated from the RBC/PLT channel (PLT distributions).
RBC-O*	RBC count calculated from the RET channel.
PLT-O*	PLT count calculated from the RET channel.
RET-Y*	The forward scattered light intensity of the RET area on the RET scattergram.
RET-RBC-Y*	The forward scattered light intensity of RBC (mature red blood cells) area on the RET scattergram.
IRF-Y*	The intensity of forward scattered light from the IRF area on the RET scattergram.
FRC#*	The absolute count calculated from the count in a specific area below the RBC area in the RET scattergram.
FRC%*	The ratio calculated from the count in a specific area below the RBC area in the RET scattergram.
RPI*	Reticulocyte Production Index.
RET-UPP*	The count in the UPP area of the RET scattergram.
RET-TNC*	The count in the TNC area of the RET scattergram.
HGB-O*	Hemoglobin concentration calculated from the RET channel.
MCHC-O*	MCHC-O is calculated by the equation $HGB-O / HCT$.
Delta-HGB*	Delta-HGB is calculated by the equation $HGB - HGB-O$.
PLT-F*	The platelet count calculated from the PLT-F channel.
H-IPF*	The ratio to the total platelet count of the count of platelets that appear in the area of stronger fluorescent light intensity within the IPF area of the PLT-F scattergram.

PLT-F2*	The platelet count with a minimum number digits of 100/ μ L calculated from the PLT-F channel.
----------------	--

* These items do not appear with all analyzer types.

3.2.3 Body fluid items for research

The Body fluid items for research below can be set to be displayed*.

* The body fluid analysis can only be performed if the instrument offers the body fluid analysis mode.

● Items for research

HF-BF#	The count in the area with stronger fluorescence than the WBC-BF area of the WDF scattergram.
HF-BF%	HF-BF count divided by WBC-BF and expressed as a percentage.
NE-BF#	The count in the NEUT area of the WDF scattergram.
NE-BF%	NE-BF count divided by WBC-BF and expressed as a percentage.
LY-BF#	The count in the LYMPH area of the WDF scattergram.
LY-BF%	LY-BF count divided by WBC-BF and expressed as a percentage.
MO-BF#	The count in the MONO area of the WDF scattergram.
MO-BF%	MO-BF count divided by WBC-BF and expressed as a percentage.
EO-BF#	The count appearing in the EO area of the WDF scattergram.
EO-BF%	EO-BF count divided by WBC-BF and expressed as a percentage.
RBC-BF2	RBC in the body fluid with a minimum number digits of 100/ μ L.

3.2.4 hsA items for research

The hsA items for research below can be set to be displayed.

* The availability of the function depends on your system configuration.

● Items for research

WBC*	WBC counted in the WDF channel.
RBC*	RBC used from RBC-I or RBC-O.
RBC-I	RBC counted in the RBC/PLT channel (RBC distribution).
RBC-O	RBC counted in the RET channel.
NEUT#*	The count in the NEUT area of the WDF scattergram.
LYMPH#*	The count in the LYMPH area of the WDF scattergram.
MONO#*	The count in the MONO area of the WDF scattergram.
EO#*	The count appearing in the EO area of the WDF scattergram.
NEUT%*	NEUT count divided by WBC and expressed as a percentage.
LYMPH%*	LYMPH count divided by WBC and expressed as a percentage.
MONO%*	MONO count divided by WBC and expressed as a percentage.
EO%*	EO count divided by WBC and expressed as a percentage.
MN#*	The count in the mononuclear area of the WDF scattergram.
PMN#*	The count in the polynuclear area of the WDF scattergram.
HF#	The count in the area with stronger fluorescence than the WBC area of the WDF scattergram.
MN%*	MN count divided by WBC and expressed as a percentage.
PMN%*	PMN count divided by WBC and expressed as a percentage.
HF%	HF count divided by WBC and expressed as a percentage.
TC#	Total nuclear cell count calculated from WDF channel.

* These parameter names are the same as the analysis parameters in [Whole Blood] / [Low WBC] / [Pre-Dilution] / [HPC] modes. In places where a parameter should be distinguished as an [hsA] mode parameter for research, its name will be appended with "(hsA)".
e.g. [WBC] analyzed in [hsA] mode: [WBC(hsA)]

3.3 hsA analysis

This section explains the hsA analysis. For details on the following, see the "Instructions for Use".

* hsA analysis can only be performed if the instrument offers the hsA analysis mode.

- Types of analysis: ➤ Instructions for Use, "Chapter 9: 9.1 Types of analysis"
- Analysis modes: ➤ Instructions for use "Chapter 9: 9.1.1 Analysis modes"

Sample types and handling

If body fluid analysis will be performed, add an anticoagulant such as EDTA or heparin as needed after collecting the sample. Analyze as soon as possible after collecting the sample. Particularly in the case of cerebrospinal fluid (CSF), it has been indicated that cell breakdown starts to occur within one hour after collection*.

* CLSI H56-A: Clinical and Laboratory Standards Institute H56-A



Caution!

Excessive mixing of a sample may cause false high values for WBC and TC# in [hsA] mode. Mix as gently as possible.

Sample volume

The required sample volume is as follows.

Type of analysis	Tube type	Sample Setting Position	Manual Analysis Menu [Cap Open]	Aspirated sample volume	Required sample volume
Manual analysis	Closed tube	Normal tube holder	OFF	200 µL	1 mL
	Open tube		ON		400 µL
	Open micro tube	Micro tube holder	-		260 µL



Information

The parameters in the hsA analysis results are for research purpose only. Do not use the analysis results of these parameters for the diagnosis of patients.

3.3.1 hsA analysis

Before performing the operation, change to manual analysis mode. For details, see steps 1 through 3 of the body fluid analysis procedure in the "Instructions for Use".

(► Instructions for Use, "Chapter 9: 9.4 Body fluid analysis")



1 In the [Change Measurement Mode] dialog box, select [hsA] and click [OK].

The dialog box will close, and the background check will start.

If the background values that result from the background check are under the allowable values, the Status indicator LED lights green and the analyzer enters the analysis preparation done state.

Checked Parameter	Acceptable Value	Remarks
WBC	$0.0010 \times 10^3/\mu\text{L}$ or less	WBC counted in the WDF channel
RBC-I	$0.0030 \times 10^6/\mu\text{L}$ or less	RBC counted in the RBC/PLT channel (RBC distribution)
RBC-O	$0.000100 \times 10^6/\mu\text{L}$ or less	RBC counted in the RET channel

For details on background check, see the "Instructions for Use".

(► Instructions for Use, "Chapter 6: 6.3.4* Execution of analyzer self-check")

* 6.3.5 in the Instructions for Use for the XN-3000/XN-3100, 6.4.5 in the Instructions for Use for the XN-9000/XN-9100.



Note:

Immediately after the analysis type is changed to [hsA], [Cap Open] is in the selected state. If you will perform closed analysis using regular sample tubes, remove the [Cap Open] checkmark.

2 Analyze the sample using manual analysis.

For details, see steps 6 through 12 of the body fluid analysis procedure in the "Instructions for Use".

(► Instructions for Use, "Chapter 9: 9.4 Body fluid analysis")

3.3.2 Checking analysis data

Settings can be configured in the [Sample Explorer] screen or the [Data Browser] screen to display the analysis parameters for [hsA] mode. In the [Sample Explorer] screen, they are displayed by adding the analysis parameters for the [hsA] mode in the [Property] dialog box. In the [Data Browser] screen, they are displayed by adding the analysis parameters for the [hsA] mode in the [User] and [Lab. Only] tabs.

For the setting, see "Instructions for Use." (►Instructions for Use, "Chapter 10: 10.11 Change layout of analysis data list", "Chapter 11: 11.6* Change layout of screen")

* 11.4 in the Instructions for Use for the XN-9000/XN-9100.

The analysis parameters in [hsA] mode are for research purpose only. For details on the analysis parameters, see the following:

(►P.47 "Chapter 3: 3.2.4 hsA items for research")



Information

- Analysis results of research parameters are indicated by a gray background to distinguish them from report analysis results. Do not use the analysis results of parameter for research, for the diagnosis of patients.
- RBC-O in [hsA] mode has been designed especially for the analysis of samples with very low RBC concentrations. For samples with RBC-O that exceeds $0.200001 \times 10^6/\mu\text{L}$, we recommend that you refer to RBC-I.

Sample Explorer



● [hsA] screen

Click the [hsA] tab in the [Sample Explorer] screen to view a list of hsA analysis data. The sub screen shows the parameters analyzed ([ITEM]), numerical data ([DATA]), marks, and the units ([UNITS]) of the sample selected in the analysis data list. If there is an abnormality in the analysis data, it is represented by masks and marks.

* For details on the Sample Explorer's functions, see the "Instructions for Use".

(►Instructions for Use, "Chapter 10: Checking analysis data (Sample Explorer)")

● Other screens

In the [Sample Explorer] screen, from the analysis data list, select a sample analyzed in [hsA] mode to view the hsA analysis data listed in the analysis data area.

Data Browser

In the [Sample Explorer] screen, double-clicking a sample analyzed in [hsA] mode displays the [Data Browser] screen. The [Data Browser] screen can be displayed on the [Main] / [Graph] / [Lab. Only] / [User] tabs.

* For details on the Data Browser's functions, see the "Instructions for Use".

(►Instructions for Use, "Chapter 11: Checking detailed analysis information (Data Browser)")

Chapter 4 Instrument Setup

This chapter explains how to configure analyzer and IPU settings.



Note:

- If an analyzer is running, an alarm will sound on the IPU and the dialog box will not open.
- Sampler analysis cannot be started on the analyzers while the analyzer settings are being configured.

4.1 Open the settings

The instrument settings consist of [Analyzer Setting] for the specific analyzer type, and [IPU Setting] for configuring IPU application settings. The settings are configured from the [Analyzer Setting] and [IPU Setting] dialog boxes. For the details on the settings and their default values, see Chapter 5. (► **P.141** "Chapter 5: 5.4 Default settings")



Open the analyzer settings

Click the [Analyzer Setting] icon to display the following dialog box.

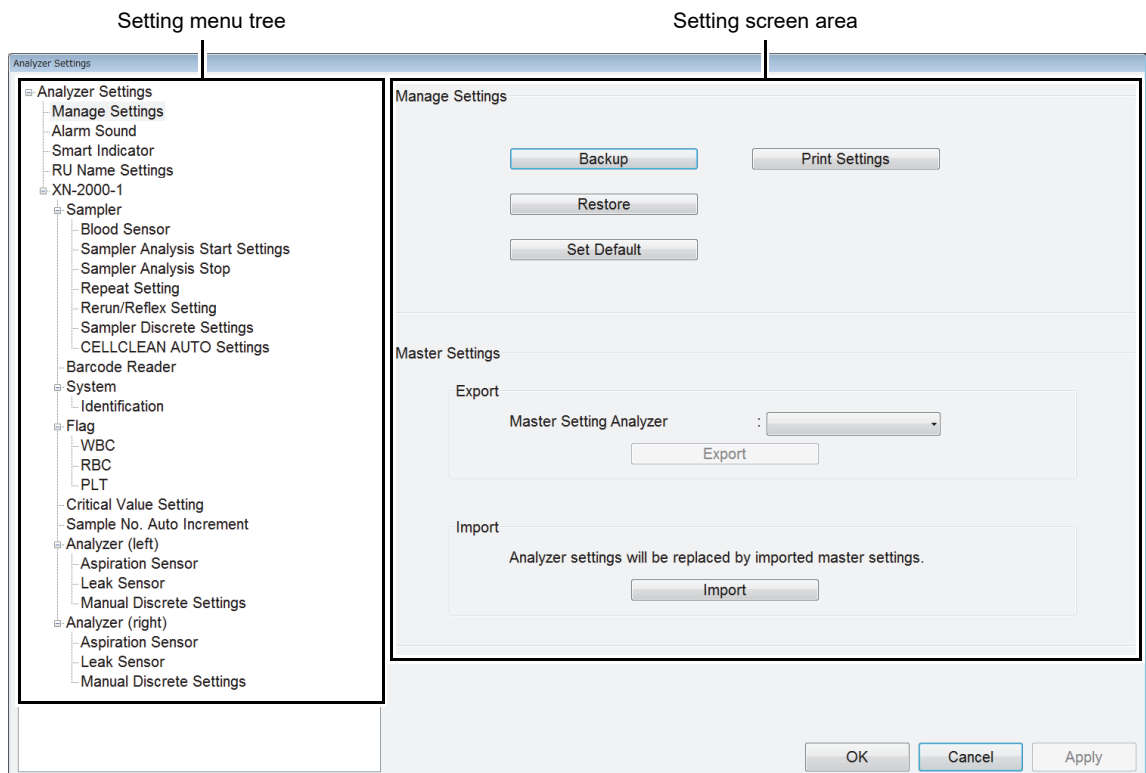

Open the IPU settings

Click the [IPU Setting] icon to display the [IPU Setting] dialog box.

The configuration of the [IPU Setting] dialog box is similar to the [Analyzer Setting] dialog box.

Setting menu tree

This shows the settings. Click an item to open a setting screen for that item on the right.

Setting screen area

The setting screen for the item selected in the setting menu tree appears.

[OK]	Save changed settings and close the dialog box.
[Cancel]	Close the dialog box without saving changed settings.
[Apply]	Save and immediately apply changed settings. The dialog box does not close.

4.2 Analyzer settings

The analyzer settings are used to configure analyzer settings, sampler system settings, and flag settings. The items shown below, which appear in the setting menu tree of the [Analyzer Setting] dialog box, can be configured*.

* When system analysis mode is selected on the XN-9000/XN-9100 or a sampler (SA-01) is used, [Sampler Analysis Start Settings] does not appear.

When a sampler (SA-01) is used, [Repeat Setting] and [Rerun/Reflex Setting] do not appear.

[Smart Indicator] is displayed only when the optional external indicator light (SI-14) is used.

- [-] Analyzer Settings
 - [-] Manage Settings
 - [-] Alarm Sound
 - [-] Smart Indicator
 - [-] RU Name Settings
 - [-] XN-2000-1
 - [-] Sampler
 - [-] Blood Sensor
 - [-] Sampler Analysis Start Settings
 - [-] Sampler Analysis Stop
 - [-] Repeat Setting
 - [-] Rerun/Reflex Setting
 - [-] Sampler Discrete Settings
 - [-] CELLCLEAN AUTO Settings
 - [-] Barcode Reader
 - [-] System
 - [-] Identification
 - [-] Flag
 - [-] WBC
 - [-] RBC
 - [-] PLT
 - [-] Critical Value Setting
 - [-] Sample No. Auto Increment
 - [-] Analyzer (left)
 - [-] Aspiration Sensor
 - [-] Leak Sensor
 - [-] Manual Discrete Settings
 - [-] Analyzer (right)
 - [-] Aspiration Sensor
 - [-] Leak Sensor
 - [-] Manual Discrete Settings

**Note:**

- For the XN-9000/XN-9100, when multiple analyzers are connected to the IPU, the name of each analyzer appears.
e.g: [XN-9100-2] and [XN-9100-3]
- For the XN-2000, XN-3000/XN-3100 or for the system configuration of XN-9100 where the analyzers are connected to CV-55, right and left is indicated next to [Analyzer].
e.g: [Analyzer (right)] and [Analyzer (left)]
- For the XN-1000, XN-1500, XN-9000 or for the system configuration of XN-9100 where the analyzers are connected to CV-50, only [Analyzer] appears.
- For the XN-1000, XN-1500 or XN-9000/XN-9100, [CELLCLEAN AUTO Settings] does not appear.
- [SP] settings only appear when the XN-1500 or XN-3000/XN-3100 (Standalone mode) is used.

4.2.1 Manage settings

Settings can be managed.

[Backup]*¹	The settings can be saved to a file. (► P.55 "Save settings")
[Restore]*²	Settings saved in a file can be restored (they will replace the current settings). (► P.56 "Restore settings")
[Set Default]*²	The settings can be returned to the default settings. (► P.56 "Initialize settings")
[Print Settings]*¹	The settings in all analyzers and samplers connected to the IPU can be printed. (► P.57 "Print settings")
[Export]*¹	Analyzer settings can be saved as a master file. (► P.57 "Save master settings")
[Import]*²	Analyzer settings can be imported from a master file. (► P.58 "Import master settings")

*1 Only displayed when setting changes have been applied. After changing a setting, click [Apply] to apply the setting.

*2 Only the [Built-in User] registered at the factory can be set.

Click [Manage Settings] in the [Analyzer Settings] tree to display the items below.

Save settings

The settings in all analyzers and samplers connected to the IPU can be saved to a file. Follow the steps below to save the settings.

1 Click [Backup].

The [Save As] dialog box appears.

2 Specify or create the folder to save the sample data into.

3 Enter the file name.

The extension of a file is ".ini".



Note:

The default file name will be
[XN][Software Version][AnalyzerSetting][Date of save_Time of save].ini.

4 Click [Save].

The settings are saved.

Restore settings

Settings can be imported from a saved file. These will replace the current settings. Follow the steps below to restore settings.

1 Click [Restore].

The dialog box on the right appears.

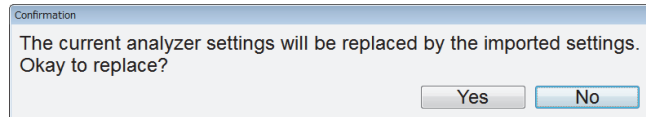

2 Click [Yes].

The [Open] dialog box appears.

3 Select the file that you wish to restore.

The extension of a file is ".ini".

4 Click [Open].

The settings are restored.

Initialize settings

The settings in all analyzers and samplers connected to the IPU can be returned to the default settings. Follow the steps below to initialize the settings.

1 Click [Set Default].

The dialog box on the right appears.

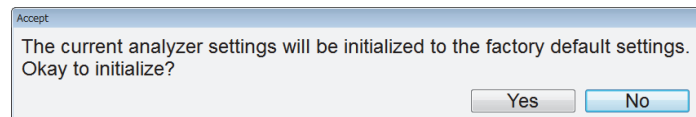

2 Click [Yes].

The settings are initialized.

Print settings

Click [Print Settings]. The settings will be printed.

The print format is ledger format. The settings are printed in 2 columns, with the first column showing the setting name and the second column showing the setting.

Save master settings

Analyzer settings can be exported as a master file. Note that identification settings will not be exported.

Follow the steps below to save the master settings.

1 Click [Export].

The [Save As] dialog box appears.



Note:

For the XN-2000, XN-3000/XN-3100 or for the system configuration of XN-9100 where the analyzers are connected to CV-55, if the left and right analyzers have different settings for [Aspiration Sensor] and [Leak Sensor], the dialog box on the right appears.

If the [Aspiration Sensor] is to be used in the master settings, select the checkbox.

To continue using [Leak Sensor] when a water leak is detected, select the checkbox.

Click [OK] to close the dialog box. The [Save As] dialog box appears.

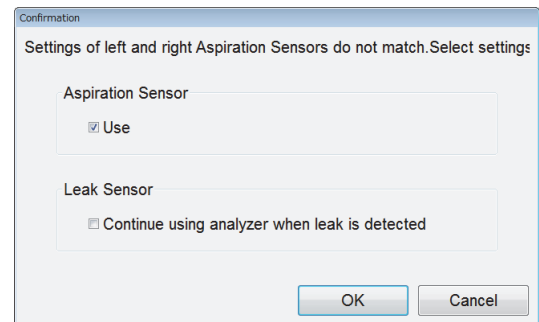

2 Specify or create the folder to save the sample data into.

3 Enter the file name.

The extension of a file is ".smf".



Note:

The default file name is in the format

[XN][Software Version][AnalyzerSettingMaster][Date of save_Time of save].smf.

4 Click [Save].

The master settings are saved.

Import master settings

When master settings are imported, the same settings are applied to all analyzers connected to the IPU. Follow the steps below to import master settings.

1 Click [Import].

The dialog box on the right appears.

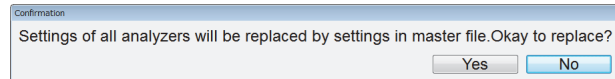

2 Click [Yes].

The [Open] dialog box appears.

3 Select the file that you wish to open.

The extension of a file is ".smf".

4 Click [Open].

The settings are replaced.



Information

After importing the master settings, check [Sampler Discrete Settings] and [Manual Discrete Settings], and set manually if needed.

If the analyzer into which the settings will be imported is a different type than the master instrument analyzer, [Sampler Discrete Settings] and [Manual Discrete Settings] may not be replaced by the master settings.

4.2.2 Alarm sound setting

Set the alarm sound that notifies the operator when an error has occurred. The alarm sound can be set separately for each analyzer.

Click [Alarm Sound] in the [Analyzer Settings] tree.

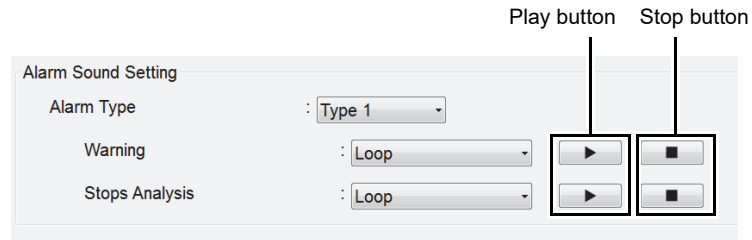

[Alarm Type]	Set the alarm type. Select from 3 types.
[Warning]	Set the alarm sound that notifies the operator when a warning error has occurred. [No Alarm], [Once], or [Loop] can be selected.
[Stops Analysis]	Set the alarm sound that notifies the operator when an analysis stop error has occurred. [No Alarm], [Once], or [Loop] can be selected.
Play button	Click to sound the selected alarm sound.
Stop button	Click to stop the alarm sound.

4.2.3 Smart indicator setting

Set the color of the LED of the optional external indicator light (SI-14) when an error has occurred. Colors can be set separately for each error.

Click [Smart Indicator] in the [Analyzer Settings] tree.

* Only when using the optional external indicator light (SI-14).

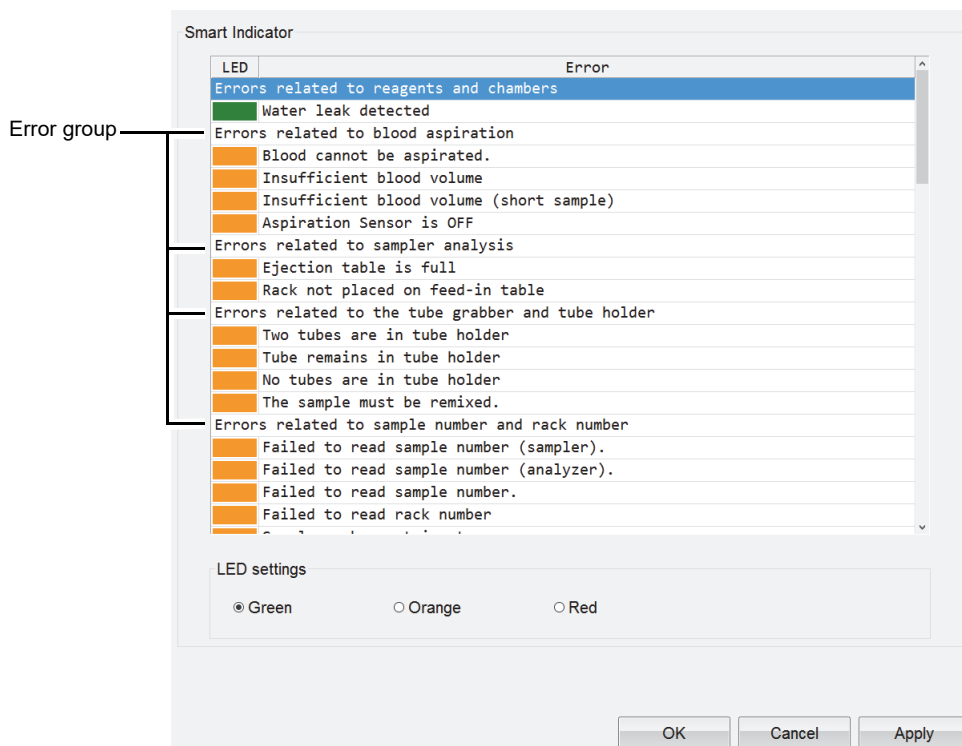

[LED]	Displays the currently set LED color.
[Error]	Displays the list of errors that LED colors can be set for.
[LED settings]	Select the LED color for the error selected on the list from [Green]/[Orange]/[Red]. When an error group is selected, LED color can be set for all errors in the selected group.

4.2.4 Reagent unit (RU-20) name setting

Set a name for the reagent unit (RU-20). The chosen name will appear in the RU area of the control menu and in the RU history screen.

Click [RU name settings] in the [Analyzer Settings] tree.

RU Name Settings	
RU-1	
RU Name	: RU-1
RU ID	: RU-20^11001
RU-2	
RU Name	: RU-2
RU ID	: RU-20^11002

[RU name]	Enter a name for the reagent unit. You can enter up to 8 characters.
------------------	---

4.2.5 Sampler settings

Sampler settings can be configured.

[Blood Sensor]	Specify whether or not the [Blood Sensor] is used. When used, the sensor detects whether or not there is blood in the sample tube. (▶P.62 "Blood Sensor setting")
[Sampler Analysis Start Settings]*¹	Specify whether or not analysis is started automatically. (▶P.62 "Analysis Start Setting")
[Sampler Analysis Stop]	Set the conditions for stopping analysis. (▶P.63 "Analysis Stop setting")
[Repeat Setting]*²	Specify whether [Repeat] analysis is performed. (▶P.64 "Repeat setting")
[Rerun/Reflex Setting]*²	Specify whether or not [Rerun] analysis / [Reflex] analysis is performed. (▶P.64 "Rerun/Reflex setting")
[Sampler Discrete Settings]	Set the discrete used for sampler analysis. This is the startup default setting. (▶P.64 "Discrete settings during sampler analysis")
[CELLCLEAN AUTO Settings]*³	Select the method used for returning CELLCLEAN AUTO from the analyzer when placing CELLCLEAN AUTO in a rack and only shutting down one of the two analyzers. (▶P.64 "CELLCLEAN AUTO Settings")

*1 When system analysis mode is selected on the XN-9000/XN-9100 or a sampler (SA-01) is used, [Sampler Analysis Start Settings] does not appear.

*2 When a sampler (SA-01) is used, this does not appear.

*3 When the XN-1000, XN-1500, or XN-9000/XN-9100 is used, this does not appear.

Blood Sensor setting

Click [Sampler] - [Blood Sensor] in the [Analyzer Settings] tree.

[Use]	Select the checkbox to have blood volume monitored during sampler analysis.
--------------	---

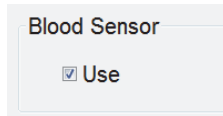



Caution!
Not using the [Blood Sensor] may affect analysis results. For [Whole Blood] mode analysis, select [Use].



Information
When a Raised Bottom Tube (RBT) is used, set the [Blood Sensor] to [Use]. In the event that the rack barcode on the RBT rack cannot be read, the RBT rack is automatically detected.



Note:
If you know in advance that a blood sample will have a very low hemoglobin (such as that of a dialysis patient), deactivate the [Blood Sensor].

Analysis Start Setting

Click [Sampler] - [Sampler Analysis Start Settings] in the [Analyzer Settings] tree*.

* When system analysis mode is selected on the XN-9000/XN-9100 or a sampler (SA-01) is used, [Sampler Analysis Start Settings] does not appear.

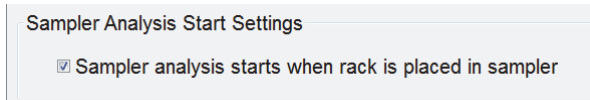

[Sampler analysis starts when rack is placed in sampler]	Select this checkbox to have sampler analysis automatically start when a rack is placed on the rack feed-in table.
---	--

Analysis Stop setting

Click [Sampler] - [Sampler Analysis Stop] in the [Analyzer Settings] tree.
Select the checkboxes of events that will stop sampler analysis.

[ID Read Error]	Unable to read the barcode label on the sample tube.
[Rack ID Read Error]*¹	Unable to read the barcode label on the rack.
[Blank Data]	When the count is abnormally low.
[Critical Value Data]	When the value is outside the set range. (▶P.70 "4.2.9 Critical Value Settings")
[Aspiration Error]	When aspiration does not take place or the amount is not sufficient. This can be set when the [Aspiration Sensor] is used. (▶P.71 "Blood aspiration sensor settings")
[Inadequate Sample]	When there is no blood. This can be set when the [Blood Sensor] is used. (▶P.62 "Blood Sensor setting")
[QC Alarm]	When the QC alarm sounds. This can be set when the QC alarm is used. (▶P.104 "QC alarm settings")
[X-barM Limit Error]	When an X-barM control error occurs in QC.
[L-J Limit Error]	When an L-J control or X-bar control error occurs in QC.
[Control Expired Error]	When the registered control has expired.
[Unregistered Control]	When an unregistered control is used.
[Reagent Expired Error]	When an expired reagent is used.
[Invalid Analysis Order]*²	An order that cannot be analyzed was specified.
[Command not to aspirate]	When not-aspirated is specified in the host computer or [Work List] screen.

Sampler Stop Conditions

- ID Read Error
- Rack ID Read Error
- Blank Data
- Critical Value Data
- Aspiration Error
- Inadequate Sample
- QC Alarm
- X-barM Limit Error
- L-J Limit Error
- Control Expired Error
- Unregistered Control
- Reagent Expired Error
- Invalid analysis order
- Command not to aspirate

*1 When the transportation controller (CT-90) or the sampler (SA-01) is used, this does not appear.

*2 When the transportation controller (CT-90) is used, this does not appear.

Repeat setting

Click [Sampler] - [Repeat Setting] in the [Analyzer Settings] tree*.

* When a sampler (SA-01) is used, this does not appear.

[Repeat]	Select this checkbox to perform [Repeat] analysis. When this function is off, [Repeat] analysis will not be performed even if a rule is set.
-----------------	---

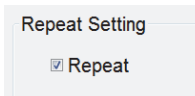

Rerun/Reflex setting

Click [Sampler] - [Rerun/Reflex Setting] in the [Analyzer Settings] tree*.

* When a sampler (SA-01) is used, this does not appear.

[Rerun/Reflex]	Select this checkbox to perform [Rerun]/[Reflex] analysis. When this function is off, [Rerun]/[Reflex] analysis will not be performed even if a rule is set.
-----------------------	---

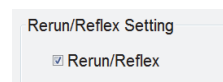

Discrete settings during sampler analysis

Click [Sampler] - [Sampler Discrete Settings] in the [Analyzer Settings] tree.

[Discrete when last ended]	Select to use the discrete* set at the end of the previous sampler analysis.
[Specified discrete]	Select to specify a discrete.

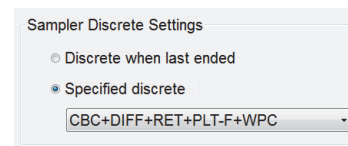

* Discretes set in [Reflex] analysis are not included.

CELLCLEAN AUTO Settings

Click [Sampler] - [CELLCLEAN AUTO Settings] in the [Analyzer Settings] tree*.

* When the XN-1000, XN-1500, or XN-9000/XN-9100 is used, this does not appear.

[Return to rack]	Select to have CELLCLEAN AUTO returned to the rack after aspiration.
[Return to tube holder]	Select to have CELLCLEAN AUTO returned to the tube holder after aspiration.

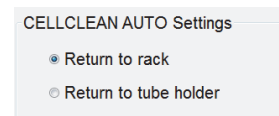

Information

When Analyzer (left) and Analyzer (right) are shut down, CELLCLEAN AUTO is always returned to the rack, regardless of this setting.

Note:

If [Return to tube holder] is selected, CELLCLEAN AUTO is returned to the tube holder after aspiration, not to the rack. You can start sampler analysis immediately without the need to wait for the analyzer to complete the shutdown cycle.

4.2.6 Barcode reader setting

Specify whether or not a barcode reader is used. Advanced settings for barcode reading can be configured. This barcode read setting is a shared setting for the overall analyzer. The setting is applied to the barcode readers of both the analyzer and the sampler.

Click [Barcode Reader] in the [Analyzer Settings] tree.

[Barcode Reader Connection]*¹	Select the checkbox to turn on the barcode reader function. When not selected, the items below are all grayed out and cannot be set.
[Read Tube ID]*¹	Select this checkbox if sample tube barcode labels will be read. When the checkbox is selected, reading settings can be configured.
[Specify Sample No. Length]	Set whether or not the number of digits read is specified. If specified, enter the number of digits (1 to 22 digits). If a number of digits other than the specified number is read, a reading error will occur. However, quality control ([QC-]) and rinse ([RN-]) sample numbers reserved in the system are not subject to the digit number check.
[Check Digits Conditions]	Select the read code checkbox to set a code. A check digit can also be set.
[ITF]	[Modulus-10]/[Through]
[CODABAR/NW7]	[Modulus-11]/[W-Modulus-11]/[Modulus-16]/[Through]
[CODE39]	[Modulus-43]/[Through]
[JAN/EAN/UPC]	Select the check box to automatically the check digit be [Modulus-10].
[ISBT128]	Select the check box to automatically the check digit be [Modulus-103].
[CODE128]	Select the check box to automatically the check digit be [Modulus-103].

[Rack ID]*²	Select this checkbox if the rack barcode label will be read. When selected, reading settings can be configured.
[Check Digits Conditions]	Select the read code checkbox to set a code. A check digit can also be set.
[CODABAR/NW7]	Select the check box to automatically the check digit be [Modulus-16]. The start/stop characters are [/D(d)-D(d)]. Use either "D" or "d" for the start/stop code.
[CODE39]	Select the check box to automatically the check digit be [Modulus-43].
[Setting for Ordering Key Read Error]	This can be set when the sample tube label or rack label read function is on. Specify whether or not a sample for which an ordering key read error occurs is analyzed.

*1 When the XN-3000/XN-3100 (Standalone mode) or the transportation controller (CT-90) is used, this is always connected. The setting is grayed out and cannot be modified.

*2 When the transportation controller (CT-90) or the sampler (SA-01) is used, this does not appear.



Warning!

When using the hand-held barcode reader, use the barcode check digit function. There is a higher potential for read errors when a check digit is not used.

4.2.7 System settings

A system name and analyzer names can be set. The name and ID of the sampler and the analyzer can be checked.

Analyzer name settings

Click [System] - [Identification] in the [Analyzer Settings] tree.

[Instrument Name]	An instrument name can be entered. The instrument name set here will appear as an error location in the error log screen. You can enter up to 11 characters.
[Sampler Name]*	The name of the sampler appears. Detailed information is displayed to the right. By the default setting, "S" (sampler) appears. The information can be changed. You can enter up to 2 characters.
[Sampler ID]*	The sampler ID number appears. The sampler ID appears in the format "Product Name^Serial Number". This cannot be changed.
[Analyzer (left)]/ [Analyzer (right)]	The analyzer name and analyzer ID appear. For the XN-1000, XN-1500, XN-9000 or for the system configuration of XN-9100 where the analyzers are connected to CV-50, only [Analyzer] appears.

[Nickname] The name of the analyzer appears. This is a number that is automatically assigned to devices connected to [Instrument Name] and the IPU. This cannot be changed.

Detailed information on the right. The default values are as follows:

[-L]: Indicates the "left" side of analyzers in the XN-2000, XN-3000/XN-3100, or connected to CV-55 in the system configuration of XN-9100.

[-R]: Indicates the "right" side of analyzers in the XN-2000, XN-3000/XN-3100, or connected to CV-55 in the system configuration of XN-9100.

[-A]: Indicates an analyzer in the XN-1000, XN-1500, or XN-9000, or connected to CV-50 in the system configuration of XN-9100.

The above information can be changed:

You can enter up to 2 characters.

[Analyzer ID] The [Analyzer ID] of the analyzer appears.

The Analyzer ID appears in the format "Instrument Product Name^Serial Number". This cannot be changed.

* When a sampler (SA-01) is used, this does not appear.

4.2.8 Flag settings

Flag settings can be configured. When the data meets specified conditions due to a specific abnormal blood conditions, an abnormal IP message will appear.

* This function is not available for hsA analysis results.

Settings can be configured for [WBC], [RBC], [PLT], and [WBC (Body Fluid Analysis)]*¹.

For the details on flags and the values*² that can be entered, see "Instruction for Use"

(▶Instruction for Use, "Chapter 11: 11.7.1*³ IP message judgment conditions and judgment methods")

*¹ The availability of this function depends on your system configuration.

*² The decimal point symbol set in Windows is displayed in the XN Series.

The only decimal point symbols displayed are "." (period) or "," (comma).

*³ 11.5.1 in the XN-9000/XN-9100 manual.

WBC flag settings

Set values that determine the display of WBC abnormal IP messages.

Click [Flag] - [WBC] in the [Analyzer Settings] tree.

Select the checkbox of a flag to have the judgment performed. The judgment values of the flag judgment items can also be set.

WBC Abnormal Flags			
<input checked="" type="checkbox"/> Neutropenia	: NEUT# <	<input type="text" value="1.00"/> 10 ³ /uL	or NEUT% < <input type="text" value="0.0"/> %
<input checked="" type="checkbox"/> Neutrophilia	: NEUT# >	<input type="text" value="11.00"/> 10 ³ /uL	or NEUT% > <input type="text" value="100.0"/> %
<input checked="" type="checkbox"/> Lymphopenia	: LYMPH# <	<input type="text" value="0.80"/> 10 ³ /uL	or LYMPH% < <input type="text" value="0.0"/> %
<input checked="" type="checkbox"/> Lymphocytosis	: LYMPH# >	<input type="text" value="4.00"/> 10 ³ /uL	or LYMPH% > <input type="text" value="100.0"/> %
<input checked="" type="checkbox"/> Monocytosis	: MONO# >	<input type="text" value="1.00"/> 10 ³ /uL	or MONO% > <input type="text" value="100.0"/> %
<input checked="" type="checkbox"/> Eosinophilia	: EO# >	<input type="text" value="0.70"/> 10 ³ /uL	or EO% > <input type="text" value="100.0"/> %
<input checked="" type="checkbox"/> Basophilia	: BASO# >	<input type="text" value="0.20"/> 10 ³ /uL	or BASO% > <input type="text" value="100.0"/> %
<input checked="" type="checkbox"/> Leukocytopenia	: WBC <	<input type="text" value="2.50"/> 10 ³ /uL	
<input checked="" type="checkbox"/> Leukocytosis	: WBC >	<input type="text" value="18.00"/> 10 ³ /uL	
<input checked="" type="checkbox"/> NRBC Present	: NRBC%	<input type="text" value="2.0"/> %	
<input checked="" type="checkbox"/> IG Present	: IG# >	<input type="text" value="0.10"/> 10 ³ /uL	or IG% > <input type="text" value="100.0"/> %

RBC flag settings

Set values that determine the display of RBC abnormal IP messages.

Click [Flag] - [RBC] in the [Analyzer Settings] tree.

Select the checkbox of a flag* to have the judgment performed.

* [Reticulocytosis] does not appear with all analyzer types.

RBC Abnormal Flags			
<input checked="" type="checkbox"/> Reticulocytosis	: RET#	>	0.2000 10 ⁶ /uL or RET% > 5.00 %
<input checked="" type="checkbox"/> Anisocytosis	: RDW-SD	>	65.0 fL or RDW-CV > 20.0 %
<input checked="" type="checkbox"/> Microcytosis	: MCV	<	70.0 fL
<input checked="" type="checkbox"/> Macrocytosis	: MCV	>	110.0 fL
<input checked="" type="checkbox"/> Hypochromia	: MCHC	<	29.0 g/dL
<input checked="" type="checkbox"/> Anemia	: HGB	<	10.0 g/dL
<input checked="" type="checkbox"/> Erythrocytosis	: RBC	>	6.50 10 ⁶ /uL

PLT flag settings

Set values that determine the display of PLT abnormal IP messages.

Click [Flag] - [PLT] in the [Analyzer Settings] tree.

Select the checkbox of a flag to have the judgment performed. The judgment values of the flag judgment items can also be set.

PLT Abnormal Flags			
<input checked="" type="checkbox"/> Thrombocytopenia	: PLT	<	60 10 ³ /uL
<input checked="" type="checkbox"/> Thrombocytosis	: PLT	>	600 10 ³ /uL

WBC flag settings (body fluid)

Set values that determine the display of WBC abnormal IP messages.

Click [Flag] - [WBC (Body Fluid Analysis)] in the [Analyzer Settings] tree.

Select the checkbox of a flag to have flag judgment performed. The judgment values of the flag judgment items can also be set.

WBC Abnormal Flag (Body Fluid Analysis)			
<input checked="" type="checkbox"/> WBC Abn Scattergram	:		
HF-BF#	>	9999.99 10 ³ /uL	or HF-BF% > 100.0 /100 WBC

4.2.9 Critical Value Settings

Upper and lower limit values can be set for each item. The set upper and lower limit values are called "critical values". Analysis data that are outside the intervals set here are displayed with an exclamation mark "!".

Sampler analysis can be set to stop when there is data with "!".

Click [Critical Value Setting] in the [Analyzer Settings] tree.

* This function is not available for hsA analysis results.

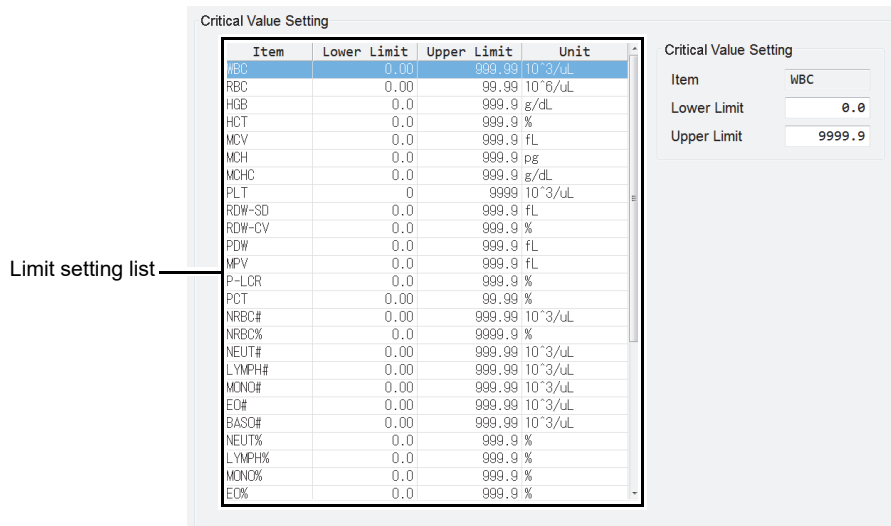

Limit setting list	Click to select an item.
[Critical Value Setting]	The settings for the item selected in the limit setting list appear.
[Item]	The item selected in the limit setting list appears. This cannot be entered.
[Lower Limit]*,	An upper limit and a lower limit can be entered.
[Upper Limit]*	If [Critical Value Setting] in the analyzer stop conditions is used, analysis will stop if a value is outside the set upper and lower limit range.

* The decimal point symbol set in Windows is displayed in the XN Series.
The only decimal point symbols displayed are "." (period) or "," (comma).

4.2.10 Sample number auto increment setting

Click [Sample No. Auto Increment] in the [Analyzer Settings] tree.

Sample No. Auto Increment Setting

Automatically increment sample number (manual mode)

[Automatically increment sample number (manual mode)] Select this checkbox to have the sample number automatically assigned as a sequential number when manual analysis is performed.

4.2.11 Analyzer settings

Analyzer settings can be configured.

Blood aspiration sensor settings

Specify whether or not the [Aspiration Sensor] is used. When used, the sensor detects if the required sample was aspirated.

* During [Pre-Dilution] / [Body Fluid] / [HPC] / [hsA] mode analysis, the blood aspiration sensor is always off, regardless of the setting.

Click [Analyzer] - [Aspiration Sensor] in the [Analyzer Settings] tree.

[Use] Select the checkbox to use the [Aspiration Sensor].

Aspiration Sensor

Use



Caution!

Not using the [Aspiration Sensor] may affect test results. For [Whole Blood] mode analysis, select [Use].



Note:

If you know in advance that a blood sample will be very thin (such as that of a dialysis patient), deactivate the [Aspiration Sensor].

Water leak sensor settings

Specify whether use of the analyzer is continued when a water leak is detected.

Click [Analyzer] - [Leak Sensor] in the [Analyzer Settings] tree.

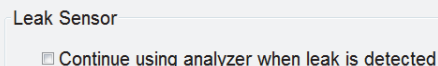

[Continue using analyzer when leak is detected]	When the checkbox is selected, use of the analyzer can be continued when a water leak is detected.
--	--



Caution!

Unless otherwise directed by your local Sysmex representative, keep the setting set to OFF. If use is continued with the setting set to ON, the instrument and other devices may be damaged if leakage occurs.

Discrete settings during manual analysis

Set the discrete used for manual analysis. This is the startup default setting.

Click [Analyzer] - [Manual Discrete Settings] in the [Analyzer Setting] tree.



[Discrete when last ended]	Select to use the discrete set at the end of the previous manual analysis.
[Specified discrete]	Select to specify a discrete.

4.2.12 SP-10/SP-50 settings

Settings related to the SP-10/SP-50 can be configured.

* Only when using the XN-1500 or XN-3000/XN-3100 (Standalone mode).

[SP Setting]	<p>The following settings related to the SP-10/SP-50 can be configured.</p> <ul style="list-style-type: none"> • Whether [SP Rule] judgment is performed. • Number of samples prepared when an SP-10/SP-50 order is not registered in the [Work List] screen. • Whether the SP-10/SP-50 smear result and reagent replacement information are output to the host computer. <p>(▶P.73 "SP Settings")</p>
[SP printer setting]	<p>Set the information that is printed on the slide glass.</p> <p>(▶P.74 "SP Printer Settings")</p>

SP Settings

Click [XN-1500-1] / [XN-3000-1] / [XN-3100-1] - [SP] - [SP Setting] in the [Analyzer Setting] tree.

* [SP Settings] only appears when the XN-1500 or XN-3000/XN-3100 (Standalone mode) is used. May not appear, depending on the instrument settings.

[SP Rule Setting]	Specify whether [SP Rule] judgment is performed.
[Perform Judgement of SP Rule]	Select the checkbox to perform [SP Rule] judgment. When this function is off, [SP Rule] judgment is not performed even if the rule is set.
[Default SP Order]	Set the number of samples prepared when an SP-10/SP-50 order is not registered in the [Work List] screen. This order is also used when there is a smear preparation instruction from the host computer.
[Number of slide]	[Do not prepare slides], [1 slide], or [2 slides] can be selected.
[slide glass (1st)]	The 1st slide glass used to prepare a smear can be specified. For the XN-1500 or XN-3100 (Standalone mode): Select [either], [Right cassette], or [Left cassette]. For the XN-3000 (Standalone mode): Select [either], [cassette 1], or [cassette 2].
[Deliver to DIA]	When this checkbox is selected, slides are delivered to the DIA.
[slide glass (2nd)]	The 2nd slide glass used to prepare a smear can be specified. For the XN-1500 or XN-3100 (Standalone mode): Select [either], [Right cassette], or [Left cassette]. For the XN-3000 (Standalone mode): Select [either], [cassette 1], or [cassette 2].
[Deliver to DIA]	When this checkbox is selected, slides are delivered to the DIA.
[Output to Host Computer setting]	Specify whether the SP-10/SP-50 smear result and reagent replacement information are output to the host computer.
[Output analysis result(SP) to Host Computer]	Select this checkbox to output the smear analysis result to the host computer.
[Output reagent replacement information(SP) to Host Computer]	When this checkbox is selected, reagent replacement information is output to the host computer.

SP Printer Settings

Click [XN-1500-1] / [XN-3000-1] / [XN-3100-1] - [SP] - [SP printer setting] in the [Analyzer Setting] tree.

* Only when the XN-1500 or XN-3000/XN-3100 (Standalone mode) is used.

[SP printer setting]	Set the information that is printed on the slide glass.
[Print format]	<p>The print format can be selected.</p> <p>For details on the print format, see the SP-10/SP-50 "Instructions For Use".</p> <p>(▶SP-10 Instructions for Use, "Chapter 13: 13.2 Printer Print Format")</p> <p>(▶SP-50 Basic Operation "Chapter 5: 5.5.4 Print type settings")</p>
[Print data]	<p>Set the information that is printed on the slide glass.</p> <p>For details on the printed information, see the SP-10/SP-50 "Instructions For Use".</p> <p>(▶SP-10 Instructions for Use, "Chapter 13: 13.2 Printer Print Format")</p> <p>(▶SP-50 Basic Operation "Chapter 5: 5.5.4 Print type settings")</p>
[1st text] to [3rd text], [Barcode]	<p>The settings below can be selected.</p> <p>[Not Printed], [Date], [Sample No.], [Patient ID], [Patient Name], [Last Name], [Sex], [Age], [Patient Comment], [Ward], [Doctor], [Sample Comment], [Fixed Text]</p> <p>If [Fixed Text] is selected, this can be entered at the left of the selection. Up to 15 characters can be entered.</p> <p>[3rd Text] cannot be entered when [Type 2] is set for [Print format].</p> <p>[Barcode] cannot be entered when [Type 1] is set for [Print format].</p>

4.3 IPU settings

The system settings of the IPU, external device connection settings, and automatic processing settings can be configured in the IPU settings.

The items shown below, which appear in the setting menu tree of the [IPU Setting] dialog box, can be configured.

(►P.52 "Open the IPU settings")

- ▣ IPU Setting
 - ▣ Manage Settings
 - ▣ System
 - Facility Information
 - System Language
 - IPU Shutdown
 - Date Format
 - User Administration
 - CSV Output
 - Security
 - Screen Keyboard
 - Patient ID Display
 - Notification of Program Updates
 - Database Optimization
 - ▣ Displayed
 - Data Grid
 - Scattergram
 - ▣ Connect
 - Host Computer
 - Ticket Printer (DP)
 - Ticket Printer (DP) Print Format
 - Printer
 - Device
 - ▣ Auto Process
 - Auto Validate
 - Auto Output
 - Analysis Ordering
 - Delta Check
 - ▣ Reference Interval
 - Category
 - Reference Interval
 - Unit
 - ▣ QC
 - QC Setting
 - QC Alarm
 - QC Chart Fixed Comment
 - QC Data Auto Output
 - Priority Code

4.3.1 Manage settings

Settings can be managed.

[Backup]*¹	The current settings in the IPU can be saved to a file. (▶P.76 "Save settings")
[Restore]*²	Settings saved in a file can be restored (they will replace the current settings). (▶P.77 "Restore settings")
[Set Default]*²	The settings in the IPU can be returned to the default settings. (▶P.78 "Initialize settings")
[Print Settings]*¹	The settings in the IPU can be printed. (▶P.78 "Print settings")

*1 Only displayed when setting changes have been applied. After changing a setting, click [Apply] to apply the setting.

*2 Only the [Built-in User] registered at the factory can be set.

Click [Manage Settings] in the [Analyzer Settings] tree to display the screen below*.

* When a user other than the [Built-in User] registered at the factory is logged on, [Restore] and [Set Default] are grayed out and cannot be selected.

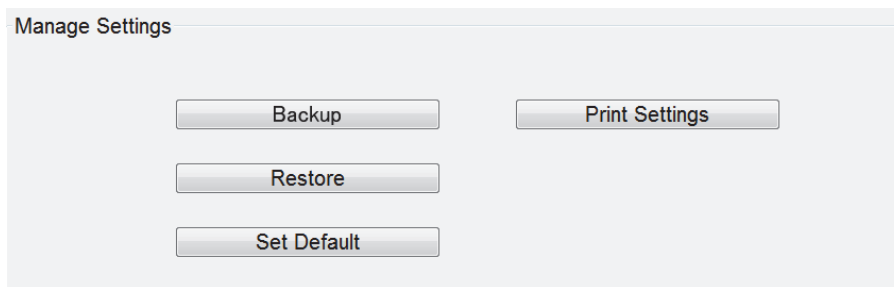

Save settings

Follow the steps below to save the settings.

1 Click [Backup].

The [Save As] dialog box appears.

2 Specify or create the folder to save the sample data into.

3 Enter the file name.

The extension of a file is ".ini".



Note:

The default file name will be
[XN][Software Version][IPUSetting][Date of save_Time of save].ini.

4 Click [Save].

The settings are saved.

Restore settings

Follow the steps below to restore settings to the IPU.

1 Click [Restore].

The [Open] dialog box appears.

2 Select the file that you wish to open.

The extension of a file is ".ini".

3 Click [Open].

The dialog box on the right appears.

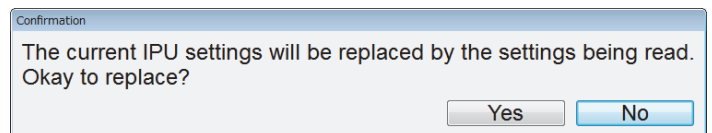

4 Click [Yes].

The settings are replaced.

**Information**

When settings are restored, the user information settings are also replaced by the restored data. Note that the [admin] (administrator) password is also replaced by the restored data.

Initialize settings

Follow the steps below to initialize the settings in the IPU.

1 Click [Set Default].

The dialog box on the right appears.

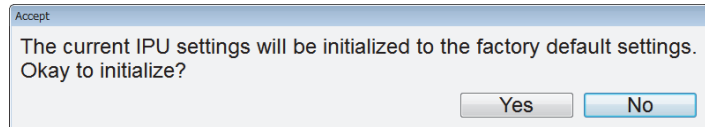

2 Click [Yes].

The settings are initialized.

 **Information**

When the settings are initialized, the user information settings are also initialized. Note that the [admin] (administrator) password also returns to the default setting.

Print settings

Click [Print Settings]. The IPU settings will be printed.

The print format is ledger format. The settings are printed in 2 columns, with the first column showing the setting name and the second column showing the setting.

4.3.2 System settings

System settings can be configured.

[Facility Information]	Set the name of the facility that is using the system. The set facility name is used when analysis data is printed out. (▶P.79 "Facility information setting")
[System Language]	Set the language that is used in the system and the language that is used in printing. (▶P.80 "Change the display language (basic system language)")
[IPU Shutdown]	Specify whether or not the IPU is automatically shut down when all devices connected to the IPU are shut down. (▶P.80 "IPU Shutdown setting")
[Date Format]	Set the format of the date that is printed and displayed on the IPU. (▶P.80 "Date format setting")
[User Administration]	Register and delete users of the instrument. User permissions can also be set. (▶P.81 "User information management (user administration)")
[CSV Output]	Specify whether image data is output when analysis data is output to CSV. If image data is output, select the output format ([BMP] or [PNG]) and the background color ([BLACK] or [WHITE]). In addition, specify whether the analysis data is divided into multiple files when the data exceeds 256 columns. (▶P.87 "CSV output settings")
[Security]	Configure patient information and screen locking settings. (▶P.87 "Security settings")
[Screen Keyboard]	Set whether or not the screen keyboard is used. (▶P.88 "Screen keyboard setting")
[Patient ID Display]	Set the display position of the patient ID. (▶P.88 "Patient ID display setting")
[Notification of Program Updates]	Set whether or not you are notified of program updates. (▶P.88 "Program Update Notification Setting")
[Database Optimization]	Set the frequency at which the database is optimized. (▶P.89 "Database Optimization Frequency Setting")

Facility information setting

Click [System] - [Facility Information] in the [IPU Setting] tree.

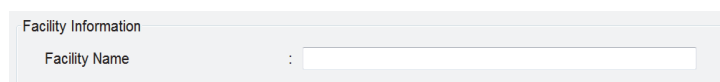

[Facility Name]	The [Facility Name] can be entered. You can enter up to 32 characters.
------------------------	---

Change the display language (basic system language)

Click [System] - [System Language] in the [IPU Setting] tree*.

* Changed settings will be applied the next time startup or logon is performed.



[Language]	The language displayed in the system can be set. [English], [German], [Italian], [Spanish], [Portuguese], [Russian], [French], [Greek], [Chinese], [Traditional Chinese], [Korean], or [Portuguese-Brazilian] can be selected.
[Print Language]	The language used for printing can be set. Languages that can be selected are the same as in [Language].

IPU Shutdown setting

Click [System] - [IPU Shutdown] in the [IPU Setting] tree.

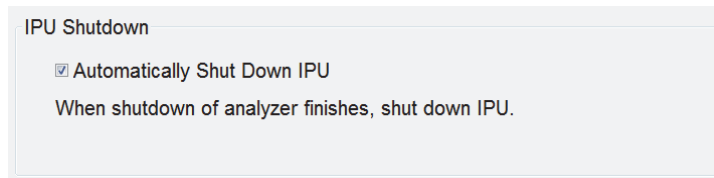

[Automatically Shut Down IPU]	Select the checkbox to have the IPU shut down automatically.
--------------------------------------	--

Date format setting

Click [System] - [Date Format] in the [IPU Setting] tree.

[General Date Format]	Select one of the following date formats.
[YYYY/MM/DD]	Year 4 digits/Month 2 digits/Day 2 digits
[MM/DD/YYYY]	Month 2 digits/Day 2 digits/Year 4 digits
[DD/MM/YYYY]	Day 2 digits/Month 2 digits/Year 4 digits

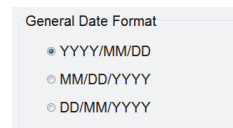

User information management (user administration)

Click [System] - [User Administration] in the [IPU Setting] tree.

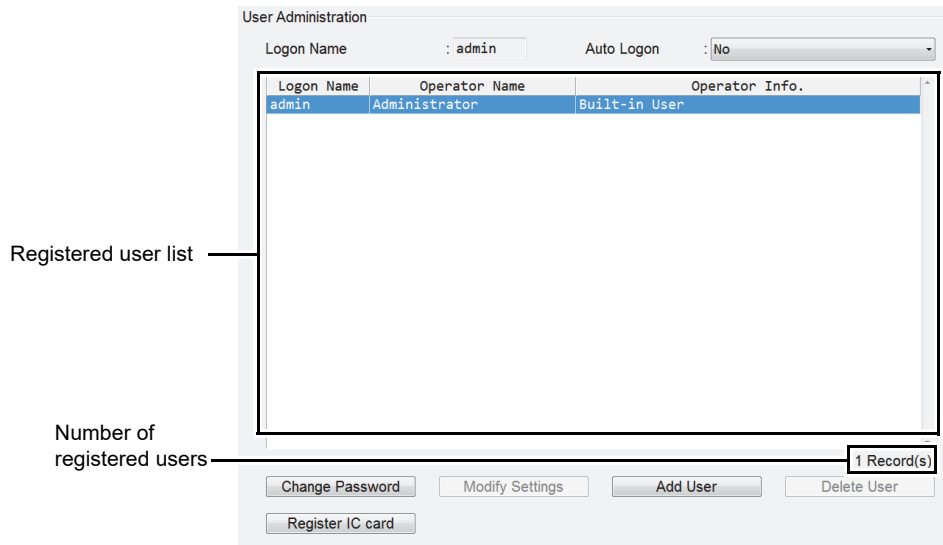

[Logon Name]	The user name of the user logged onto the IPU appears.
[Auto Logon]	Select the user for auto logon. When [Same as OS Account Name] is selected, logon takes place using the same name as the OS account name when the IPU is started. If the same name cannot be found, auto logon does not take place.
Registered user list	The registered users are displayed. [Logon Name], [Operator Name], and [Operator Info.] appear. [Built-in User], which appears in [Operator Info.], indicates a factory registered user. A built-in user cannot be deleted or changed.
Number of registered users	The number of registered users is displayed.
[Change Password]	Click to display the dialog for changing the password. (▶P.82 "Change the password")
[Modify Settings]	Click to display the dialog for changing user settings*. (▶P.83 "Change settings and add users")
[Add User]	Click to display the dialog for adding a user. When the maximum number of users (101) have been registered, a user cannot be added. (▶P.83 "Change settings and add users")
[Delete User]	Click to delete a user. [admin] (instrument administrator) cannot be deleted. (▶P.85 "Delete a user")
[Register IC card]	Click to display a dialog box that allows you to register/reset an IC card for logon. (▶P.85 "Register or change an IC card information", P.86 "Reset an IC card information")

* You can also double-click the user you want to change in the registered user display list to open a dialog box.



Information

The factory default password for [admin] (instrument administrator) is "m116m".
Change the password before using the instrument.

Change the password

Follow the steps below to change the password.

1 Click [Change Password].

The dialog box on the right appears.

The screenshot shows a standard Windows-style dialog box titled "Change Password". It has three text input fields stacked vertically, each preceded by a colon. The labels are "Current Password", "New Password", and "Re-enter New Password". At the bottom right of the dialog, there are two buttons: "OK" and "Cancel".



Note:

- The logged on user can change his or her password.
- Users with [All Administrators] authority can change the passwords of other users. For permission settings, see the following section:
(►P.83 "Change settings and add users")

2 Populate the displayed fields.

[Current Password]	Enter the current password. A user with [Built-in User] or [All Administrators] authority does not need to enter the password.
[New Password]	Enter the new password. You can enter up to 20 characters.
[Re-enter New Password]	Re-enter the new password for confirmation.

3 Click [OK].

The password is changed.

Change settings and add users

Follow the steps below to change settings or add a user.

1 Click [Modify Settings] or [Add User].

The dialog box on the right appears.



Note:

The maximum number of users that can be registered is 20. This does not include factory registered users.

2 Populate the displayed fields.

● Set basic user information.

[Logon Name]	Enter the logon name of the user. You can enter up to 6 characters. If the dialog box is opened from [Modify Settings], this cannot be modified.
[Language]	Select the language that is displayed for the user. For the languages that are available, see the following. (► P.80 "Change the display language (basic system language)")
[Operator Name]	Enter the name of the logon user. You can enter up to 20 characters.
[Operator Info.]	Enter additional information related to the user. You can enter up to 100 characters.

● Set user permissions.

[All Administrators]	Select to give the user all permissions below.
[Set separately]	Select to separately specify the items below.

[Order Registration]	Select this check box to permit order registration. If not selected, the user cannot open the [Work List] screen.
[Instrument Analysis]	Select this check box to permit analysis of samples. If not selected, the user cannot perform analysis.
[Modify / Delete Results]	Select this check box to permit modification/deletion of analysis results.
[Validate]	Select this check box to permit validation of results.
[Display and Output of Research Items]	Select this check box to grant authority to display items for research in the [Data Browser] screen and the [Sample Explorer] screen, and to grant authority to output externally (csv output, graphic printer (GP) printing).
[Input and delete QC Lot Information, Operate plot]	Select this check box to permit input and deletion of QC sample lot information, plot operation, and [Cursor Data Management]. You can specify permission details. Select [All operations] or [Only QC Plot operation]. If [Only QC Plot operation] is selected, permission is only given for plot operation and [Cursor Data Management]. QC sample lot information cannot be entered or deleted.
[Calibration]	Select this check box to permit calibration.
[Modify Settings]	Select this check box to permit modification of settings.
[Display and Modify Patient Info.]	Select this check box to permit display and modification of patient information. [Patient Information] can be included in the saved data of Sample Explorer and in CSV file output. However, this must also be set in [Security]. (►P.87 "Security settings")
[Output Results]	Select this check box to permit external output.
● Set shift.	
[Shift]	Select the shift. QC result plots can be viewed for each shift.

3 Enter the password.

Enter the new password (twice).

If settings are being modified, the dialog box on the right does not appear. Go to the next step.

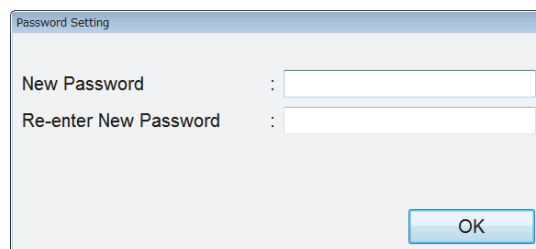

The image shows a dialog box titled "Password Setting". It contains two text input fields. The first field is labeled "New Password" and the second is labeled "Re-enter New Password". Both fields are currently empty. At the bottom right of the dialog box, there is an "OK" button.

4 Click [OK].

The dialog box closes, the settings are changed or the users are added.

Delete a user

Follow the steps below to delete a user.

1 Click the user that you wish to delete in the list.

The user is selected.



Note:

- Users with [All Administrators] authority can delete other users.
- A [Built-in User] cannot be deleted.

2 Click [Delete User].

The dialog box on the right appears.

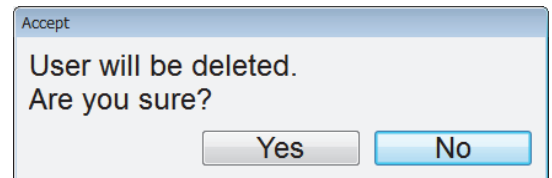

3 Click [Yes].

The selected user will be deleted.

Register or change an IC card information

Follow the steps below to register or change an IC card information.

1 Select the user for registration or change of IC card information from the list.

The user is selected.

2 Click [Register IC card].

The dialog box on the right appears.

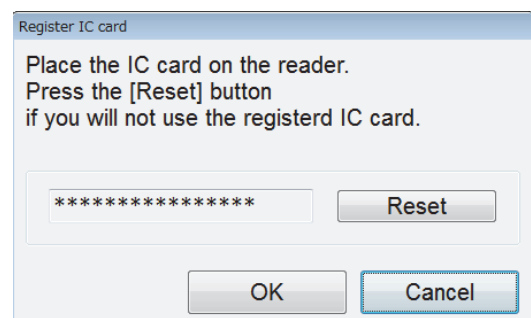

3 Hold up the IC card to be registered or changed to the IC card reader.

The IC card information is registered, and [*****] is displayed.

4 Click [OK].

The dialog box closes.

Reset an IC card information

Follow the steps below to reset an IC card information.

1 Select the user for reset of IC card information from the list.

The user is selected.

2 Click [Register IC card].

The dialog box on the right appears.

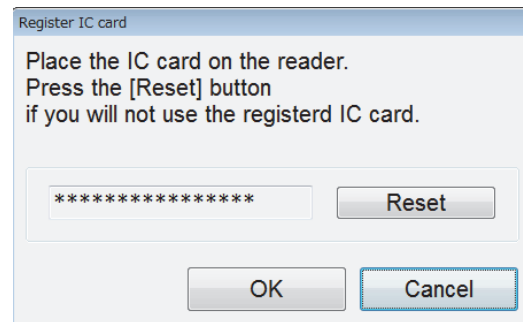

3 Click [Reset].

A confirmation dialog box appears.

4 Click [OK].

The dialog box closes, and the IC card information is deleted.

CSV output settings

Click [System] - [CSV Output] in the [IPU Setting] tree.

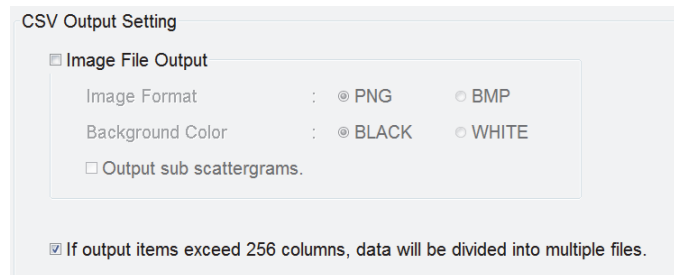

[Image File Output]	Select the check box to have an image output when data is saved in CSV format. The image format ([PNG]/[BMP]) and background color ([BLACK]/[WHITE]) can be selected.
[Output sub scattergrams.]	Select the check box to output the sub scattergrams.
[If output items exceed 256 columns, data will be divided into multiple files.]	Select the check box to divide into multiple files if the output items exceed 256 columns.

Security settings

Click [System] - [Security] in the [IPU Setting] tree.

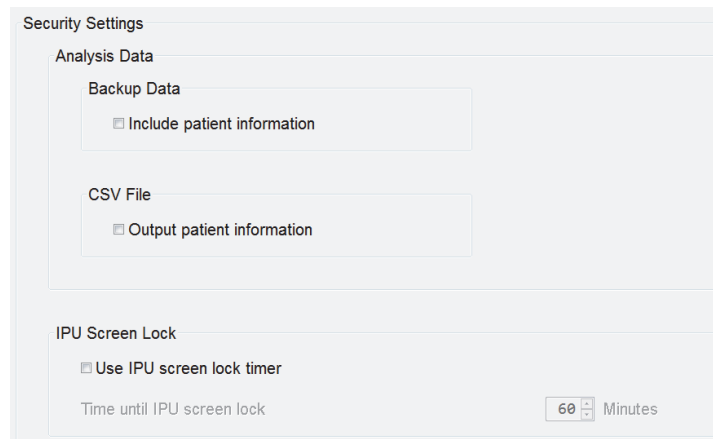

[Include patient information]	Select the check box to include [Patient Information] when saving analysis data.
[Output patient information]	Select the check box to include [Patient Information] when outputting analysis data to a CSV file.
[Use IPU screen lock timer]	Select the check box to turn on the IPU screen lock timer. When the IPU screen lock timer is used, the IPU screen will lock and operation will not be possible if the mouse or keyboard of the IPU is not used for the time set with the timer.
[Time until IPU screen lock]	The time until the screen is locked by the IPU screen lock timer can be set. The time can be set from 15 to 60 minutes in increments of 1 minute.

Screen keyboard setting

Click [System] - [Screen Keyboard] in the [IPU Setting] tree.

[Use screen keyboard]	Select the check box to enable use of the screen keyboard. Click an input box to display the screen keyboard. The screen keyboard is a Windows function.
------------------------------	--

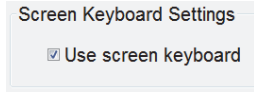

Patient ID display setting

Click [System] - [Patient ID Display] in the [IPU Setting] tree.

[Patient ID Display Settings]	Set patient ID display to [Right-justified] or [Left-justified]*.
--------------------------------------	---

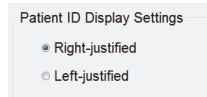

* The patient ID displayed in the patient information area is always left-justified, regardless of the setting.

Program Update Notification Setting

Click [System] - [Notification of Program Updates] in the [IPU Setting] tree.

[Notify when ready to install program update]	Select to be notified when program updates are ready to be installed.
--	---

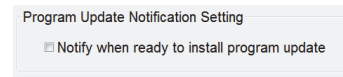

Database Optimization Frequency Setting

Click [System] - [Database Optimization] in the [IPU Setting] tree.

[Frequency of Database Optimization] You can select [High], [Middle], or [Low] for the frequency at which database optimization is executed.

Frequency of Database Optimization

- High
 Middle
 Low



Note:

- Database optimization is a function that increases the amount of free space by organizing the information in the database. To ensure stable use of the system, it is necessary to periodically optimize the database. You can select the optimization frequency as appropriate for your usage environment. The optimization interval and time required for each setting are as follows.

Setting	Interval			Time required*
	600 analyses per day	400 analyses per day	200 analyses per day	
[High]	12 days	19 days	37 days	10 minutes
[Middle]	37 days	56 days	112 days	15 minutes
[Low]	87 days	131 days	262 days	25 minutes

* The time required will vary depending on your usage environment.

- Database optimization will be executed when all instruments connected to the IPU are shut down. The following dialog box appears during optimization. When optimization is finished, the IPU shuts down as specified in the [IPU Shutdown] setting. (►P.80 "IPU Shutdown setting")

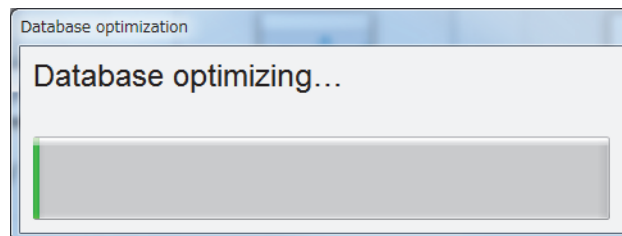

4.3.3 Display settings

Display settings can be configured.

[Data Grid]	A data grid (line height and character size of lists) can be set. (▶ P.90 "Data grid setting")
[Scattergram]	The background color of a scattergram can be set. (▶ P.90 "Scattergram setting")

Data grid setting

Click a font size button on the list screen of each screen to change the data grid.

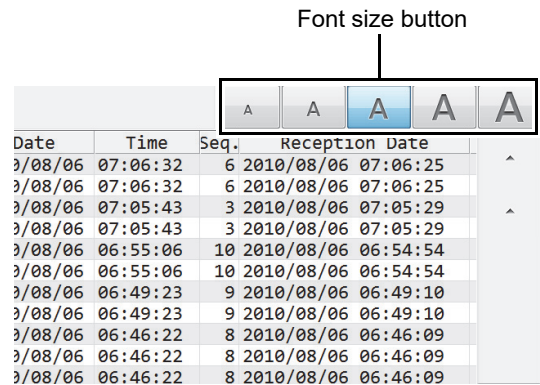

Click [Displayed] - [Data Grid] in the [IPU Setting] tree, and then set each item to change the data grid.

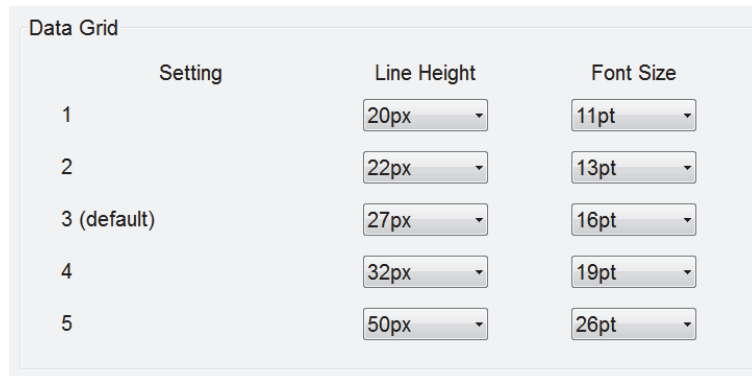

[Setting]	The numbers displayed on the font size button of the list screen of each screen appear.
[Line Height]	The line height can be set. Set to a height from 20 to 50 pixels in increments of 1 pixel.
[Font Size]	The size of characters displayed on the screen can be set. Set to a size from 11 to 30 points in increments of 1 point.

Scattergram setting

Click [Displayed] - [Scattergram] in the [IPU Setting] tree.

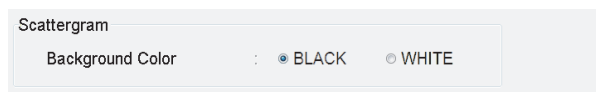

[Background Color]	The background color ([BLACK]/[WHITE]) of a scattergram can be selected.
---------------------------	--

4.3.4 Connection settings

Connection settings can be configured.

[Host Computer]	Configure host computer connection and communication settings. (▶P.91 "Host computer connection")
[Ticket Printer (DP)]	Set the ticket printer connection and print display format. (▶P.93 "Ticket printer (DP) connection")
[Ticket Printer (DP) Print Format]	Set the items printed by the ticket printer and the print positions. (▶P.94 "Ticket (DP) print format settings")
[Printer]	Set connection of the graphic printer and list printer. (▶P.95 "Graphic printer (GP)/List printer (LP) connection")
[Device]	Set connection of the IC card reader. (▶P.95 "IC card reader connection")



Note:

Only when a host computer and printers are connected, the output destinations of the [Output] button on the toolbar will be displayed.

Host computer connection

Click [Connect] - [Host Computer] in the [IPU Setting] tree.

[Host Computer Connection]	Select the checkbox to enable connection to a host computer. When this is not selected, interface settings cannot be configured.
[Current Connection]	Select [Host Computer 1] or [Host Computer 2]. Connection is only possible to 1 host computer. Up to 2 host computers can be registered.
Selection tabs	Click to display the connection settings of [Host Computer 1] or [Host Computer 2].

[Host Computer Name]	Enter the name of the host computer. The name entered here will appear in the host menu. You can enter up to 8 characters.
[Serial Connection]	Select to connect to the host computer by serial connection. Detailed parameters can be configured.
[Port Setting]	Select the port used for the host computer connection. A serial port can be selected.
[Port Settings]	The following settings are available.
[Baud Rate]	Select the transmission speed.
[Code]	Select the data bit length.
[Stop Bit]	Select the stop bit length.
[Parity Bit]	Select the parity check method.
[Interval]	Select the interval for transmission to the host computer.
[Format]	Select the serial communication format. [XN series Sysmex Standard] or [XN series ASTM] can be selected*. When [XN series ASTM] is selected, the class cannot be selected.
[Class]	Select the transmission method.
[TCP/IP Connection]	Select to connect to the host computer by TCP/IP. Detailed parameters can be configured.
[Host IP Address]	Set the IP address of the host computer.
[Port No.]	Set the port number of the host computer. A value from 0 to 65535 can be entered.
[Format]	Select the communication format for TCP/IP. [XN series Sysmex Standard] or [XN series ASTM] can be selected*.

* To use format other than the above, service settings are required.



Note:

The host computer to which the system connects can be changed in the host menu. Click [HOST] in the host computer area of the analyzer control menu to display the host menu.

Ticket printer (DP) connection

Click [Connect] - [Ticket Printer (DP)] in the [IPU Setting] tree.

[DP Connection]	Select to connect to the ticket printer (DP). When not selected, the items below are grayed out and cannot be set.
[Select Printer]	Select the printer to be connected. Only the [TM-U295] can be selected. Connect the printer to the IPU with a parallel cable. In some cases it is possible to connect to other than the above printer by means of a model change.
[Print Format]	The print format can be set.
[Sample No. Length]	Set the number of sample number digits that are printed. Any number from 1 to 22 can be selected.
[Date Print Type]	Set the format of the printed date. [YYMMDD], [MMDDYY], [DDMMYY], [DDMM], or [MMDD] can be selected. Y: Year (2 digits), M: Month (2 digits), D: Day (2 digits).
[Delimiter of Date]	Select the delimiter ([/], [Space], or [No Space]) used in the printed date. e.g: May 5, 2010 Slash: 10/05/05 Space: 10 05 05 No space: 100505
[Print Decimal Point]	Specify whether decimal points in data are printed.
[Top Margin]	Set the margin between the top of the ticket and the print start position in the indicated inch-based units. A value from 8 to 255 can be set.
[Char. Pitch]	Set the character pitch in dots. A value from 5 to 21 can be set.
[Line Pitch]	Set the line pitch in the indicated inch-based units. A value from 8 to 255 can be set.
[Print Headstand]	Specify whether headstand printing is performed.

Ticket (DP) print format settings

Click [Connect] - [Ticket Printer (DP) Print Format] in the [IPU Setting] tree.

* This function is not available for hsA analysis results.

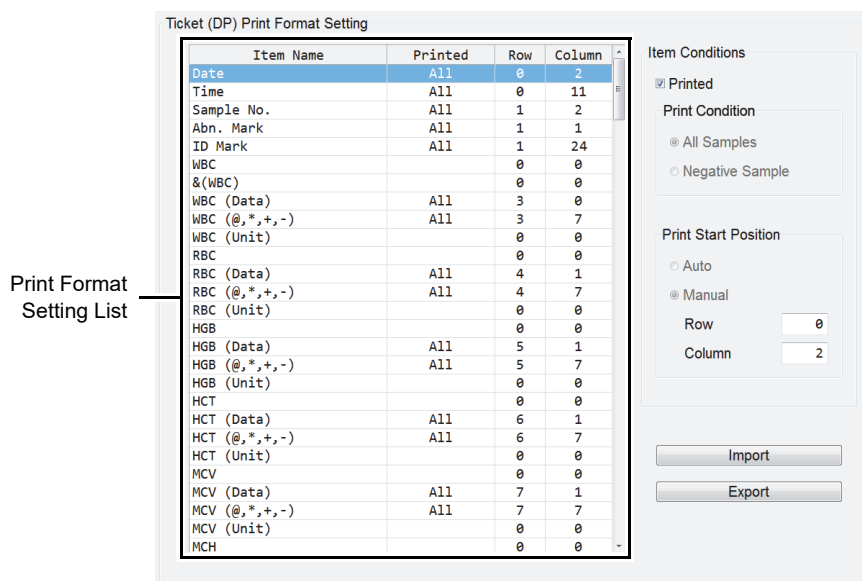

Print Format Setting List

Click the items that you wish to print.

Displays only the reportable items.

In date data, allowance must be made for any print spaces specified in Date Print Type and Delimiter of Date. In sample numbers, allowance must be made for any print spaces specified in Sample No. Length. Make sure the print spaces of items do not overlap.

[Printed]

Select the check box to have the item printed. Print details can be set.

[Print Condition]

Select the samples to be printed. For items with "&" after the item name, [All Samples] is always selected.

[Print Start Position]

[Auto] or [Manual] can be selected.

When [Manual] is selected, set [Row] or [Column] for the print start position. A value from 0 to 255 can be entered.

Set the column based on the print position of the most significant digit of each analysis item.

[Import]

A saved ticket (DP) print format can be imported. The extension of a file is ".dpf".

The default file name is [XN][Software version][DPFormat].dpf.

The procedure is the same as for importing master settings.

(►P.58 "Import master settings")

[Export]

The current ticket (DP) print format settings can be saved to a file.

The extension of a file is ".dpf".

The procedure is the same as for exporting master settings. (►P.57 "Save master settings")



Information

If the row or column setting is incorrect, some analysis results may not be printed or printing will not be complete. Set the row and column to the correct position.

Depending on the state of adjustment of the printer and the length of the paper, printing may not take place correctly even if the content is within the possible layout range.

Graphic printer (GP)/List printer (LP) connection

Click [Connect] - [Printer] in the [IPU Setting] tree.

Printer Connection Settings

Report (GP) Connect

Ledger (LP) Connect

[Report (GP) Connect] Select the check box to connect to a graphic printer.

[Ledger (LP) Connect] Select the check box to connect to a list printer.

IC card reader connection

Click [Connect] - [Device] in the [IPU Setting] tree.

Device settings

IC card reader

Serial port :

[Serial port] Select the serial port to connect the IC card reader.

4.3.5 Automatic processing settings

Automatic processing settings can be configured.

[Auto Validate]	Specify whether validation takes place automatically. Set the samples to be validated. (►P.96 "Auto validate settings")
[Auto Output]	Specify whether output takes place automatically. Set the output destination. (►P.97 "Auto output settings")
[Analysis Ordering]	Set the keys and method used to query the host computer for analysis information. (►P.98 "Analysis ordering")
[Delta Check]	Specify whether delta check is performed. (►P.99 "Delta check settings")

Auto validate settings

Click [Auto Process] - [Auto Validate] in the [IPU Setting] tree.

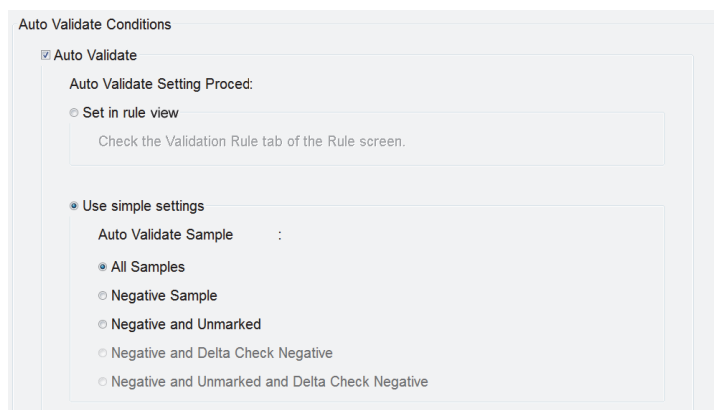

[Auto Validate]	Select the check box to have samples automatically validated. Select whether validation conditions are set in the rule screen or using the simple settings.
[Set in rule view]	Select to enable the settings in [Validation Rule] in the rule screen.
[Use simple settings]*	Select to enable the simple settings. Select samples to be validated. When [Use simple settings] is selected, the settings in the rule screen are disabled.

* Only when setting the delta check, the items including "Delta Check Negative" are displayed. (►P.99 "Delta check settings")

When auto validated samples are [All Samples], samples are validated regardless of the analysis mode.



Information

If you are using transportation controller (CT-90), an order is queried from the transportation controller to the host computer. Therefore, be sure to select the [Auto Validate] check box, and select [Use simple settings] - [All Samples].



Note:

An analysis result which has been validated only can be output.

Auto output settings

Click [Auto Process] - [Auto Output] in the [IPU Setting] tree.

Auto Output Destination and Output Conditions		Negative Data	Diff. Posi.	Morph. Posi.	Count Posi.
<input type="checkbox"/> DP	<input type="checkbox"/>	<input type="checkbox"/>	<input type="checkbox"/>	<input type="checkbox"/>	<input type="checkbox"/>
<input type="checkbox"/> GP	<input type="checkbox"/>	<input type="checkbox"/>	<input type="checkbox"/>	<input type="checkbox"/>	<input type="checkbox"/>
<input type="checkbox"/> HC	<input type="checkbox"/>	<input type="checkbox"/>	<input type="checkbox"/>	<input type="checkbox"/>	<input type="checkbox"/>

[Auto Output]	Select to have validated samples automatically output. The following settings are available.
[Set in rule view]	Select to enable the settings in the rule screen. Analysis data will be automatically output based on [Validation Rule] and [Output Rule].
[Use simple settings]	Select to set [Error Data Output Conditions] and [Auto Output Destination and Output Conditions]. When [Do not automatically output data with errors] is selected, data with errors are not output to any of the output destinations, regardless of the output conditions.
Output destination	Set the auto output destination.
[DP]	Select the check box to enable output from the ticket printer. Output conditions can be selected.
[GP]	Select the check box to enable output from the graphic printer. Output conditions can be selected.

[HC]	Select the check box to enable output from the host computer. Output conditions can be selected.
Output conditions	Set the output conditions.
[Negative Data]	When this is selected, data with neither any items judged abnormal nor any analysis errors are selected.
[Diff. Posi.]	When this is selected, sample data with abnormal blood cell differentiation are selected.
[Morph. Posi.]	When this is selected, sample data with abnormal blood cell morphology are selected.
[Count Posi.]	When this is selected, sample data with abnormal blood cell counts are selected.

**Note:**

Data that have already been transmitted are not output by auto output.

Analysis ordering

Click [Auto Process] - [Analysis Ordering] in the [IPU Setting] tree.

[Key Setting]*	Select [Sample No.] or [Rack No./Tube Pos.]. When there are pending orders in the [Work List] screen, the order key cannot be changed. When [Rack No./Tube Pos.] is selected, sample tube labels are not read.
[Realtime Host Order Setting]	Specify whether real-time queries are sent to the host computer when [Manual Analysis] or [Sampler Analysis] is performed.
[Manual Analysis]	Select to have host ordering performed during manual analysis. The order key is the sample number.
[Sampler Analysis]	Select to have host ordering performed during sampler analysis. The order key can be set.

* When the transportation controller (CT-90) is used, this is always [Sample No.]. This cannot be selected.

Delta check settings

Click [Auto Process] - [Delta Check] in the [IPU Setting] tree.

[Perform Delta Check] Select the check box to have delta check performed.

Delta Check Setting

Perform Delta Check

● Delta check

Purpose	Detects the possibility of the following errors: Possibility of sample mix-up. Possibility of a sample or instrument problem
Method	The difference between the data being judged and the previous analysis data is obtained using the [Patient ID] as a keyword.
Checked parameters	WBC, HGB, MCV, PLT. If the previous analysis was performed more than four days earlier, WBC judgment is not performed. * Analysis data from [Body Fluid] / [HPC] / [hsA] mode are not checked by delta check.
Display	[Check] is displayed in the [Action] column of the [Sample Explorer] screen and in the Action field of the [Data Browser] screen. The following Delta check details can be viewed in the [Data Browser] screen. <ul style="list-style-type: none"> • [The sample might be wrong. Check the sample.] • [Significant change in WBC. Check the sample.]* * The analysis parameter is an example. WBC, HGB, MCV, or PLT may appear, depending on the judgment.



Note:

Using the patient ID as a keyword, delta check compares the most recent analysis data with the previous analysis data and judges if the data is abnormal based on any changes in the data.

- If you are using multiple analyzers, you can compare data with a same patient ID across analyzers.
- When multiple IPUs are used with the transportation controller (CT-90), analysis data cannot be compared between IPUs.

4.3.6 Reference interval settings

The reference interval settings can be configured.

[Category]	Set the patient categories by age and gender. (►P.100 "Category settings")
[Reference Interval]	Set the values based on which abnormal judgments are made. (►P.101 "Reference interval settings")

Category settings

Click [Reference Interval] - [Category] in the [IPU Setting] tree.

	Lower Age Limit			Upper Age Limit			Sex
	Year	Month	Week	Year	Month	Week	
<input checked="" type="checkbox"/> Category 1	0	0	0	0	0	1	Both
<input checked="" type="checkbox"/> Category 2	0	0	1	0	1	0	Both
<input checked="" type="checkbox"/> Category 3	0	1	0	1	0	0	Both
<input checked="" type="checkbox"/> Category 4	1	0	0	12	0	0	Both
<input checked="" type="checkbox"/> Category 5	12	0	0	60	0	0	Male
<input checked="" type="checkbox"/> Category 6	12	0	0	60	0	0	Female
<input checked="" type="checkbox"/> Category 7	60	0	0	299	0	0	Both

[Category 1] to [Category 7]	Select the category to be used.
[Lower Age Limit], [Upper Age Limit]	Enter values in [Year], [Month], and [Week]. [Year], [Month], and [Week] of [Lower Age Limit] and [Upper Age Limit] are the time elapsed after birth, not a date.
[Sex]	The gender can be specified.



Note:

If there is no information on the age or gender, or there is no applicable category, the limits of the universal category are automatically used.

Reference interval settings

Click [Reference Interval] - [Reference Interval] in the [IPU Setting] tree.

* This function is not available for hsA analysis results.

Setting Reference Interval

Specify Patient Category :

Age Range : Year 0 Month 0 Week 0 to Year 0 Month 0 Week 1

Sex : Both

Item	Lower Limit	Upper Limit	Unit
WBC	3.00	15.00	10 ³ /uL
RBC	2.50	5.50	10 ⁶ /uL
HGB	8.0	17.0	g/dL
HCT	26.0	50.0	%
MCV	86.0	110.0	fL
MCH	26.0	38.0	pg
MCHC	31.0	37.0	g/dL
PLT	50	400	10 ³ /uL
RDW-SD	37.0	54.0	fL
RDW-CV	11.0	16.0	%
PDW	9.0	17.0	fL
MPV	9.0	13.0	fL
P-LCR	13.0	43.0	%
PCT	0.17	0.35	%
NEUT#	1.50	7.00	10 ³ /uL
LYMPH#	1.00	3.70	10 ³ /uL
MONO#	0.00	0.70	10 ³ /uL
EO#	0.00	0.40	10 ³ /uL
BASO#	0.00	0.10	10 ³ /uL
NEUT%	37.0	72.0	%
LYMPH%	20.0	50.0	%
MONO%	0.0	14.0	%
EO%	0.0	6.0	%
BASO%	0.0	1.0	%
TG#	0.00	7.00	10 ³ /uL

Setting Reference Interval

Item :

Lower Limit :

Upper Limit :

List of reference interval values

[Specify Patient Category]	Set the patient category. One of categories 1 to 7, or category 8 (the universal category), can be selected.
[Age Range]	The age range of the selected patient category appears.
[Sex]	The gender of the selected patient category appears.
List of reference interval values	Click an item to select it. Settings for the selected item can be configured in [Setting Reference Interval] at the right. All items cannot be displayed at once. Scroll the screen to display items that do not appear. [Unit] cannot be changed in this dialog box. To set the units, see the following section: (▶P.102 "4.3.7 Unit settings (Unit)")
[Setting Reference Interval]	The current settings of the item selected in the list appear. An abnormal judgment of analysis data is made based on this reference interval.
[Item]	The selected item appears. This cannot be entered. When multiple analyzers are connected to the IPU, analyzable items can be set for any of the analyzers.
[Lower Limit]*, [Upper Limit]*	The lower limit and upper limit for judging abnormalities can be entered. You can enter up to 6 characters. If a reference interval is not needed, set the lower limit to [0] and the upper limit to a high value such as 999.9.

* The decimal point symbol set in Windows is displayed in the XN Series.
The only decimal point symbols displayed are "." (period) or "," (comma).



Note:

When the analysis data of an item exceeds the upper or lower limit, "+" or "-" will appear to the right of the data.

4.3.7 Unit settings (Unit)

Click [Unit] in the [IPU Setting] tree.

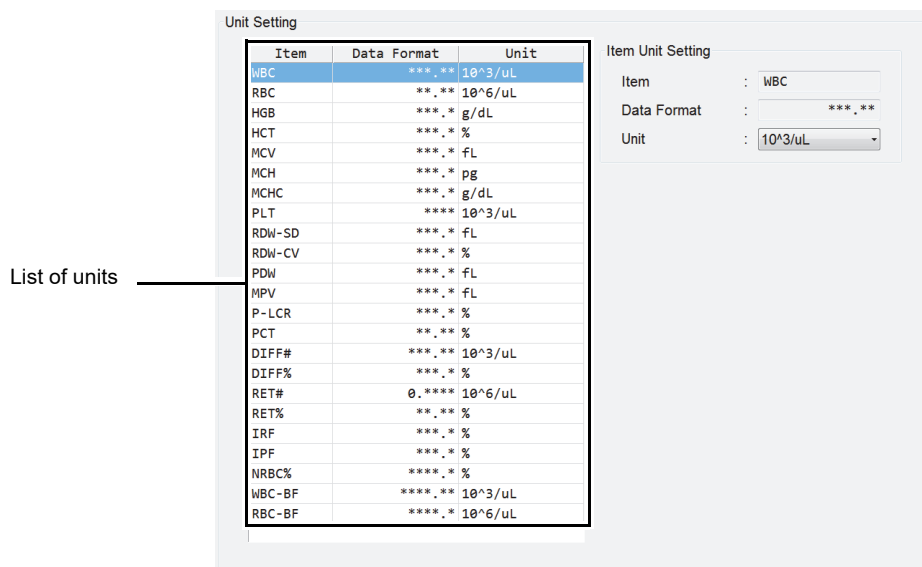

List of units	Click an item to select it. Settings for the selected item can be configured in [Unit Setting] at the right.
[Item Unit Setting]	The current settings of the item selected in the list appear.
[Item]	The item selected in the list appears. This cannot be changed.
[Data Format]*	The data format of the item selected in the list is indicated using [*] and [.]. This cannot be changed. When multiple analyzers are connected to the IPU, analyzable items can be set for any of the analyzers.
[Unit]	Click to set the units. The units that can be selected vary depending on the item. When the units are changed, the displayed data format changes accordingly.

* The decimal point symbol set in Windows is displayed in the XN Series.
The only decimal point symbols displayed are "." (period) or "," (comma).

4.3.8 QC settings

Quality control settings can be configured.

[QC Setting]	Set the quality control method and other basic settings. (►P.103 "QC settings")
[QC Alarm]	Configure settings for alarms that prompt you to perform QC. (►P.104 "QC alarm settings")
[QC Chart Fixed Comment]	Set fixed comments that can be added to plots in QC charts. (►P.105 "QC chart fixed comment settings")
[QC Data Auto Output]	Specify whether or not the plot data is output to a host computer when QC data is plotted on a QC chart. (►P.106 "QC data auto output settings")

QC settings

Click [QC] - [QC Setting] in the [IPU Setting] tree.

[QC Method Setting]	Select the QC method.
[Limit Setting]	Specify whether the QC limit value is calculated from the average (target) using the [Differential (#)] method ([SD]) or the [Ratio (%)] method ([CV]) .
[Auto Limit Setting]	Specify whether the limit used for auto limit is twice [SD] or [CV] ([2SD]) or 3 times [SD] or [CV] ([3SD]).
[X-barM Batch Setting]*	Set the number of samples (batches) per X-barM QC plot for each discrete item. Any number from 0 to 99 can be set.

* These discrete samples do not appear with all analyzer types.

QC Setting

QC Method Setting

X-bar L-J

Limit Setting

Differential (#) Ratio (%)

Auto Limit Setting

2SD 3SD

X-barM Batch Setting

Number of CBC Samples

Number of DIFF Samples

Number of RET Samples

Number of PLT-F Samples

Number of WPC Samples

QC alarm settings

Click [QC] - [QC Alarm] in the [IPU Setting] tree.

The screenshot displays the 'QC Alarm Setting' window. It contains three sections, one for each alarm (Alarm 1, Alarm 2, and Alarm 3). Each section includes a 'Time' field with hour and minute spinners, and a 'Repeating Day Specification' section. The 'Repeating Day Specification' section has two radio buttons: 'Everyday' (selected) and 'Specify Day'. Under 'Specify Day', there are checkboxes for each day of the week: Sunday, Monday, Tuesday, Wednesday, Thursday, Friday, and Saturday. In the 'Specify Day' configuration, Monday through Saturday are checked, while Sunday is unchecked.

[QC Alarm Setting]	Settings for alarms that prompt you to perform QC can be configured. 3 alarms can be registered.
[Alarm 1] to [Alarm 3]	When selected, the set alarm will sound. If the checkmark is removed, the time and day cannot be set. The settings will be grayed out and cannot be clicked.
[Time]	Set the time that the alarm will sound. Hour: A value from 00 to 23 can be set. Minute: A value from 00 to 59 can be set.
[Repeating Day Specification]	Set the day that the alarm will sound. [Everyday] or [Specify Day] can be selected.

QC chart fixed comment settings

Click [QC] - [QC Chart Fixed Comment] in the [IPU Setting] tree.

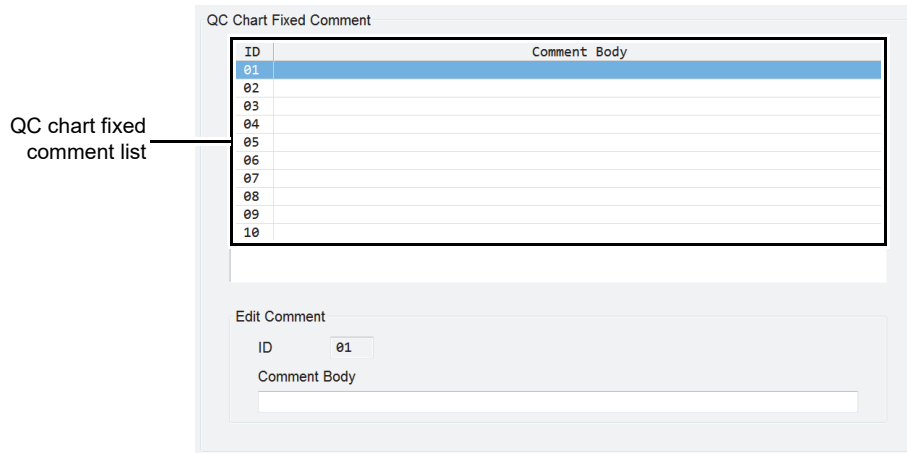

QC chart fixed comment list	Displays the [ID] and [Comment Body] of each QC chart fixed comment.
[Edit Comment]	A comment selected in the list can be edited.
[ID]	ID numbers from 01 to 10 appear. An ID number cannot be changed.
[Comment Body]	A comment can be entered. If a comment cannot be fully displayed, [...] appears at the end. You can enter up to 100 characters.

QC data auto output settings

Click [QC] - [QC Data Auto Output] in the [IPU Setting] tree.

QC Chart Data Auto Output Setting

QC Chart Screen

Automatically output plot data to host computer.

- QC Files (Excluding X-barM)
- X-barM Files

Explorer Screen

Output analysis results of sample numbers starting with QC to location below.
(Will be "already validated")

- Graphic Printer (GP)
- Host Computer (HC)
- Ticket Printer (DP)

[QC Chart Screen]	Automatic output settings can be configured. When selected, [QC Files (Excluding X-barM)] and [X-barM Files] output can be set. To output QC chart data, a connection to a host computer is required. (►P.91 "Host computer connection") When the checkmark is removed, all items are grayed out and cannot be clicked.
[Explorer Screen]	The output destination for analysis results of sample numbers beginning with "QC-" that are received in the Explorer screen can be set. Select the check box to output from the [Graphic Printer (GP)], [Host Computer (HC)], or [Ticket Printer (DP)].

4.3.9 Priority code settings

Click [Priority Code] in the [IPU Setting] tree.

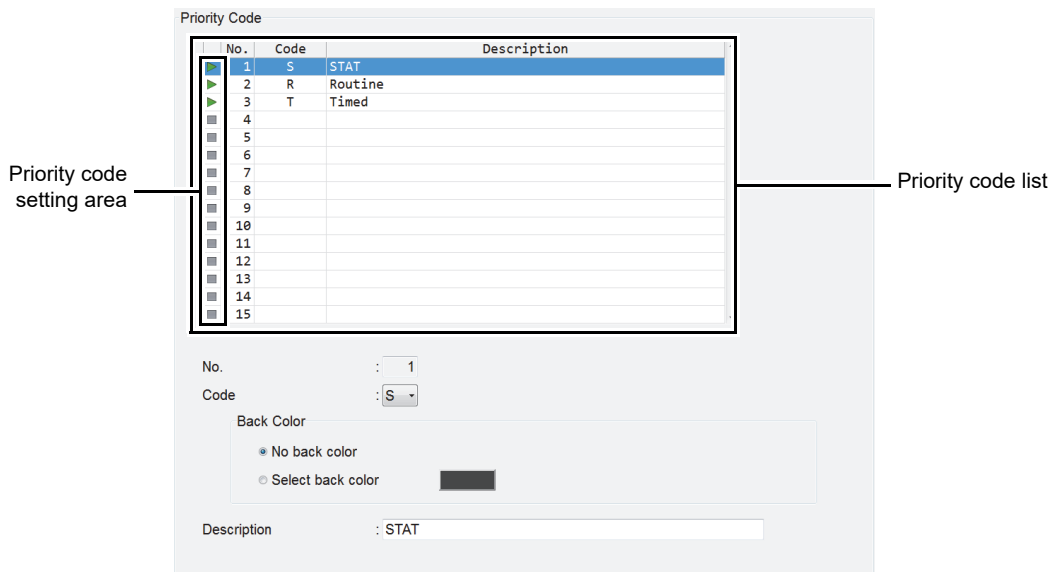

Priority code list	Click an item to select it.
Priority code setting area	Displays whether the priority code is enabled ([▶]) or disabled ([□]).
[No.]*	Displays numbers from 01 to 15. They cannot be changed.
[Code]	Select the priority code. If you select a priority code other than "blank", the code is enabled.
[Back Color]	Select [No back color] or [Select back color]. Select [Select back color] to set the background color for the priority code.
[Description]	A comment can be entered. You can enter up to 50 characters.

* This does not indicate the priority level.

4.4 Graphic printer print settings (GP customize)

Analysis data, cumulative data, QC charts, and other data can be printed graphically from a graphic printer. The GP customize function can be used to configure the print settings of the graphic printer.



Warning!

- The data output in the lab format is for research purposes. Do not use for the diagnosis of patients.
- When report format is displayed in the layout screen, items for research cannot be displayed in the template.

4.4.1 GP customize function

Setting the text to be printed and the image format

The following print settings can be configured.

- Text
- Line
- Image format (BMP)
- Table

Printing analysis data

The data below can be printed in a specified color at a specified location.

- Sample information
- Analysis data
- Reference intervals for abnormality judgments
- Scattergrams*¹
- Distributions*¹
- IP messages
- Q-Flag*²

*1 Colors cannot be specified.

*2 Lab format only.

Outputting print information

The print date and time, user name, software version, facility name, instrument name and other print-related information can be output.

Printing from a graphic printer

Analysis data, scattergrams, QC charts, and other information can be printed from a graphic printer.

[Report Format]	Select the [Output] button on the toolbar and click [Report (GP)].
[Lab Format]	Select the [Output] button on the toolbar and click [Report for Lab Use Only].

4.4.2 GP customize screen

The content printed by the graphic printer can be set in the GP customize screen.

Click the [GP Customize] icon in the menu screen to display the [GP Customize] screen.

To exit, click [File] - [EXIT] on the menu bar.

The screen consists of the following parts.

The screenshot shows the GP Customize interface. On the left is a **Selection palette** with icons for Select, Free Text, Text Data, Line, Sample Info, Analysis Items, Reference Interval, Scattergram, Distribution, IP Message, and Q-Flag. The central **Layout screen** displays a report with patient information (Sample No 8123456789, Patient ID 8123456789, Ward AAAAAA, Birth 2008/01/01, Sex Male, Nickname XM-2008-1-1) and a table of test results. Below the table are scattergrams for WDF, WNR, WPC, RET, PLT-F, RBC, and PLT. On the right is the **Property display area**, divided into **Shared properties** (Name: Data36, X: 0, Y: 120, Width: 40, Height: 15) and **Specific properties** (Field ID, Item Name: WBC, Font: CONSOLAS, Font Size: 12.0 Points, Color: Select, Align: Left).

Toolbar

The button of the following functions are displayed.

[New]	Click to open a dialog for creating a new layout.
[Save]	This can be clicked when the layout has been changed. This temporarily saves the layout of the current layout screen.
[Select All]	Click to select all objects in the layout screen.
[Delete]	This can be clicked when an object is selected. Click to delete an object selected in the layout screen.

[Copy]	This can be clicked when an object is selected. Click to copy an object selected in the layout screen.
[Paste]	Click to paste a copied object on the layout screen.
[Order]	This can be clicked when an object is selected. Clicking this displays a list of sorting options. A sorting option can be selected to change the order of the objects. [Move Forward (F)], [Move Backward (B)], [Move to Front (I)], or [Move to Back (S)] can be selected.
[Align]	This can be clicked when an object is selected. Clicking this displays a list of alignment options. Select an alignment option to align the objects. [Left Aligned (L)], [Right Aligned (R)], [Top Aligned (O)], [Bottom Aligned (Q)], [Justify Vertically (H)], [Justify Horizontally (J)], [Center Vertically (K)], [Center Horizontally (M)], [Center Vertically in Rectangle (V)] or [Center Horizontally (T) in Rectangle], can be selected.
[Undo]	Click to undo the previous operation.
[Redo]	Click to cancel [Undo].
[Backup]	The print layout of the current layout screen can be saved. (►P.115 "4.4.3 Save layout")
[Restore]	Replaces the current layout screen with the layout of the file that is opened. (►P.116 "4.4.4 Restore saved layout")
[Cancel Template]	Click to clear an object in a template. Table edit items cannot be cleared.
[Image]	Any image can be added to the layout screen. A dialog box for selecting the image file appears. Image format is BMP.
[Table]	A table can be added to the layout screen. Click to open a dialog for setting the table.
[Rectangle Display]	Click to show edit frames around each item on the layout screen. Edit frames allow you to check for overlapping items.
[Grid]	Click to show/hide the grid on the layout screen. Showing the grid makes it easier to check the size and position of objects.
[Zoom]	Click to change the zoom of the layout image. 100%, 150%, or 200% can be selected.

Selection palette

Select the template and the items to be printed. (►P.111 "Selection palette")
The selected content appears in the layout screen.

Layout screen

Shows the print layout.
Use the tabs to switch between [Report Format] and [Lab Format].
(►P.112 "●Tabs", ►P.112 "Layout screen")

Property display area

This shows the items selected in the layout screen and the template properties. The properties can be set.
(►P.112 "Properties")

Selection palette

The following items are shown in the selection palette.

[Selection]	Click to change the layout screen to selection mode.
<p>● Text and lines</p> <p>Details for each edit item are displayed in the specific properties. An item on the selection palette can also be clicked to display the item on the layout screen. A displayed item can be clicked to edit the item from the properties display area.</p>	
[Free Text]	Click to set the character size, color, and other settings. When the layout screen is clicked, a text frame appears. A text frame can also be displayed by dragging on the layout screen.
[Text Data]	The text data of a set item can be edited. When the layout screen is clicked, a text frame appears. A text frame can also be displayed by dragging on the layout screen.
[Line]	Click to configure line settings.

● Template

Sample information and analysis items are arranged in sets of names and values. Frequently used combinations of edit items are pre-grouped in a template.

Click the [New] button on the toolbar to open a dialog for selecting the template. A template can be selected from the list that appears in the dialog.

To cancel a template, click the [Cancel Template] icon on the toolbar. Table edit items cannot be canceled. The size of a template cannot be changed.

[Sample Info]	Click to set the sample information template.
[Items]	Click to set the analysis items template.
[Scattergram]	Click to set the scattergram template.
[Distribution]	Click to set the distribution template.
[IP message]	Click to set the IP message template.
[Reference Interval]	Click to set the reference interval template.
[Q-Flag]	Click to set the Q-Flag template.



Note:

- Up to 15 edit items can be placed in the selection palette.
- If the layout screen is switched to a different format, the edit item palette changes to the state in which [Selection] is selected.

Layout screen

The layout screen shows the print image.

The selected edit items and template appear in the layout.

The layout area is 196 X 259 mm. The print size is A4 (210 x 297 mm).



Note:

A dummy image will appear in the layout screen.

● Tabs

The print format is changed using the tabs.

[Report Format]	Click to select report format. Sample information and report items are printed. Only validated data can be printed.
[Lab Format]	Click to select lab format. Sample information, report items, and research items are printed. Samples that have not been validated can also be printed. Printed with "Lab Use Only" on a gray background.

Properties

The properties of the item that is selected in the layout screen are displayed. Details can be set for each item. When an item is not selected on the layout screen, the properties do not appear.

● Shared properties

Detailed information common to all edit items is displayed.

[Name]	The name of the item. Immediately after an item is selected for editing, the default name ("Item" + "Serial number") appears. This name can be changed. You can enter up to 32 characters.
[X]	The X coordinate of the item on the layout screen. This can be entered within the range 0 to 555 pt.
[Y]	The Y coordinate of the item on the layout screen. This can be entered within the range 0 to 733 pt.
[Width]	The width of the item. This can be entered within a range up to 556 pt. The lower limit of the range varies depending on the object.
[Height]	The height of the item. This can be entered within a range up to 734 pt. The lower limit of the range varies depending on the object.



Note:

The position of the X and Y coordinates is displayed based on the point at the top left of the item.

● Specific properties

Specific details are shown for each edit item. The settings can be changed by selecting items and entering numerical values.

List of specific property edit items

Selection item/template in layout screen	Edit item	Description
Free text ([Free Text])	[Text]	Shows the text string. The text string can be entered and edited.
	[Font]	The text font can be selected.
	[FontSize]	The text size can be entered and edited.
	[Color]	Shows the current text color. [Selection] can be clicked to open the color selection dialog and change the text color.
	[Align]	The text alignment can be selected.
Item name, numerical value, mark, units ([Text Data])	[Field ID]	Type Selection: [Item Name], [Data], [Mark], or [Unit] can be selected. Item Selection: Shows selection items based on the type. The items that can be selected vary depending on whether the format is report or lab.
	[Font]	The text font can be selected.
	[FontSize]	The text size can be entered and edited.
	[Color]	Shows the current text color. [Selection] can be clicked to open the color selection dialog and change the text color.
	[Align]	The text alignment can be selected.
Any image ([Image])	[File Name]	Shows the image file path. Click the button to select an image.
	[Fix Aspect Ratio]	Select to fix the aspect ratio of the image.
	[Width Ratio]	The image width can be set as a percentage. When [Fix Aspect Ratio] is ON, links with the [Height Ratio] value.
	[Height Ratio]	The image height can be set as a percentage. When [Fix Aspect Ratio] is ON, links with the [Width Ratio] value.
Scattergram, distribution image ("Image Field")	[Field ID]	Type Selection: [Scattergram] or [Distribution] can be selected. Item Selection: Shows selection items based on the type. The items that can be selected vary depending on whether the format is report or lab.
	[Width Ratio]	The image width can be set as a percentage. Links with the [Height Ratio] value.
	[Height Ratio]	The image width can be set as a percentage. Links with the [Width Ratio] value.
Line ([Line])	[LineStyle]	The line style can be selected.
	[LineWidth]	The line width can be selected.

Selection item/template in layout screen	Edit item	Description
Table ([Table])	[LineStyle]	The table line style can be selected.
	[LineWidth]	The table line width can be selected.
	[Rows]	The number of rows in the table can be set.
	[Cols]	The number of columns can be entered.
	[MarginX]	The left and right margin of text in table cells can be set.
	[MarginY]	The margin above and below text in table cells can be set.
Table cell ("Table cell")	[Text]	Shows the text string in the cell. The text string can be entered and edited.
	[Font]	The text font can be selected.
	[FontSize]	The text size can be entered and edited.
	[Color]	Shows the current text color. [Selection] can be clicked to open the color selection dialog and change the text color.
	[Align]	The text alignment can be selected.
Sample information template	[Item Name]	Sample information can be selected.
Analysis item template	[Item Name]	An analysis item can be selected.
Scattergram template	[Item Name]	A scattergram can be selected.
Distribution template	[Item Name]	A distribution can be selected.
IP message template	[Item Name]	An IP message can be selected.
Reference interval template	[Item Name]	An analysis item that allows selection of a reference interval can be selected.
Q-flag template	[Item Name]	A suspect message can be selected.

4.4.3 Save layout

The print layout that currently appears in the layout screen can be saved. Follow the steps below to save the layout.

1 Click the **[Backup]** button on the toolbar.

The [Save As] dialog box appears.

2 Specify or create the folder to save the sample data into.

3 Check a file name.

The extension for a file is ".gpf".

**Note:**

The default file name is in the following format:

- Report Format: [XN][Software version][GPFormat(Report)].gpf
- Lab Format: [XN][Software version][GPFormat(LabOnly)].gpf

4 Click **[Save]**.

The layout is saved.

4.4.4 Restore saved layout

Saved layout can be restored.

Follow the steps below to restore saved layout.

1 Click the [Restore] button on the toolbar.

The [Open] dialog box appears.

2 Select the file that you wish to restore.

The extension for a file is ".gpf".

3 Click [Open].

The layout selected for the layout screen is displayed.

Combinations of restorable files

Combinations of restorable files are as follows. The background image of the lab format will not be restored.

File to be restored	Restore location display	
	For report use	For lab use
For report use	✓	✓
For lab use	-	✓

4.4.5 Initialize layout

Layout that have been set can be initialized.

Follow the steps below to initialize layout.

1 Click the [File] - [Initialize] button on the menu bar.

An initialization confirmation dialog box appears.

2 Click [Yes].

The display of the layout screen is initialized.

4.5 Transportation controller settings (CT-90)

This section explains the procedure for configuring transportation controller settings.

Transportation controller settings are only necessary when the XN-9000/XN-9100 is used.

The transportation controller starts automatically when the Startup switch (BT-40/ST-41*/TS-10) is touched. The transportation controller can also be started separately by turning on the power of its PC unit.

The transportation controller connects to the XN conveyor (CV-50/CV-55*), SP conveyor (CV-60/CV-65*), start yard/stock yard(ST40/41/42), barcode terminal (BT-40), and Automated Tube Sorter (TS-10). The transportation controller issues the command to send samples to the analyzers. The controller also manages analysis data and performs sample searches.

System configuration and analysis order settings can be changed from the setting screen of the transportation controller. The setting screen is displayed on the touch panel that is connected to the transportation controller.

* Only when using the XN-9100.

4.5.1 Transportation controller system settings (CT-90)

System settings and host connection settings can be configured from the main screen in the transportation controller.

Syst. Setting

Follow the steps below to configure the system settings.



1 Touch the [Setting] button on the toolbar.

A dialog box appears.

2 Configure the settings that appear.

The following items appear.

- Syst. settings

[Default conveyor destination when host order is not received]

When host order is not received, specify the analyzer to which samples are sent.

[Default conveyor destination when there is a sample number reading error] Set the analyzer to which samples are sent for which an ID read error occurred.

● **Host CX set.**

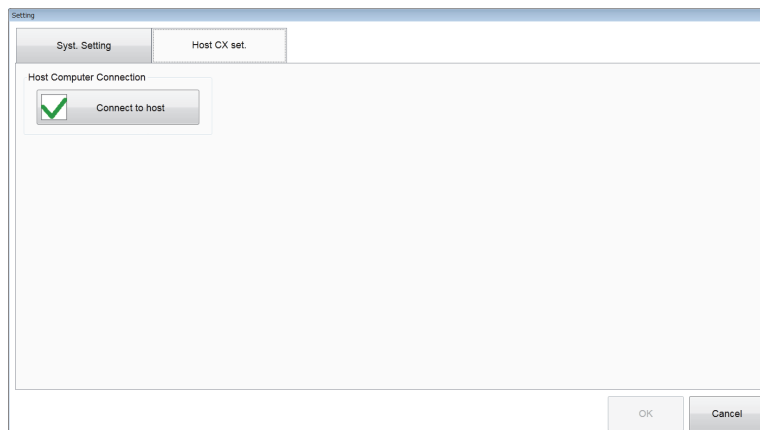

[Connect to host] Select the check box to connect to the host.

3 Touch [OK].

The system settings are changed.

4.6 RU-20 Reagent Unit Settings

This section explains how to configure the settings on the RU-20 Reagent Unit.

When the RU-20 is used, the settings can be changed from the RU area of the control menu.

When the power switch on the main unit is switched on, the RU-20 starts up.

The RU-20 dilutes concentrated reagent (CELLPACK DST) with purified water (RO water) and supplies the prepared reagent to a connected hematology analyzer or hematology slide preparation unit.

For details on the RU-20, see the RU-20 "Instructions For Use".

* The initial settings for the RU-20 are sent from the main unit.

4.6.1 Reagent Expiration Stop and Alarm Settings

The RU-20 settings dialog can be used to configure reagent expiration stop and alarm settings.

Follow the steps below to configure the settings.



1 Click the RU menu button in the control menu.

The dialog box on the right appears.

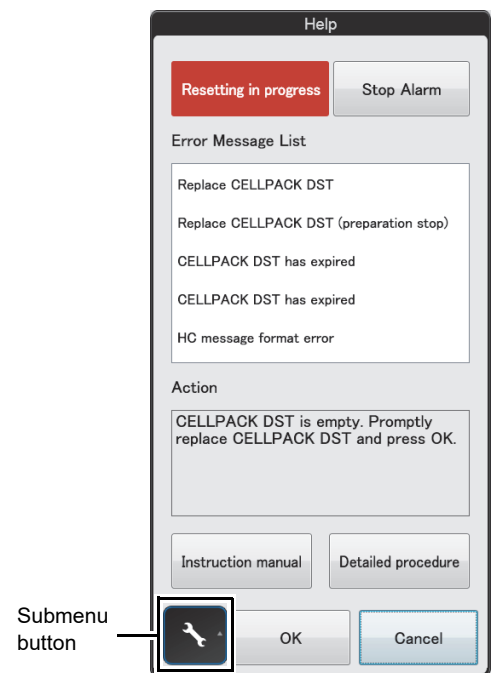

2 Click the submenu button.

The submenu on the right appears.

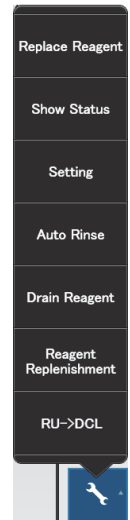

3 Click [Setting].

The dialog box on the right appears.

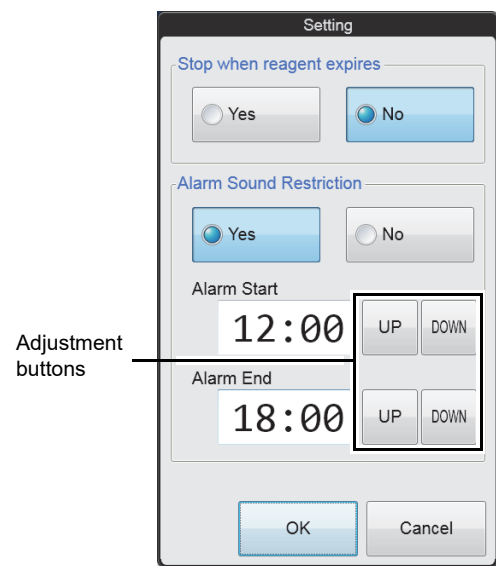

4 Configure the settings that appear.

The following settings appear.

[Stop when reagent expires]	Stops reagent preparation when the reagent expires. [Yes] or [No] can be selected.
[Alarm Sound Restriction]	Alarm activation can be restricted to a set time period. [Yes] or [No] can be selected. If you selected [Yes], click the adjustment buttons to set the [Alarm Start] time and [Alarm End] time. Alarms will only sound during the specified time period.

5 Click [OK].

The settings are changed.

4.6.2 Temporarily use CELLPACK DCL

When the RU-20 cannot be used due to a failure or other problem, you can temporarily use CELLPACK DCL.

Information

- Temporary use of CELLPACK DCL is an emergency measure that is to be employed in the event that a problem occurs on the RU-20. If a problem occurs on the RU-20, contact your Sysmex service representative as soon as possible.
- When CELLPACK DCL is used on a temporary basis, the aspiration intake of the dispensing kit will not reach the bottom of the reagent container, and thus it will not be possible to use all the CELLPACK DCL in the container.
- If the CELLPACK DCL runs out or drops to a level that cannot be aspirated during temporary use of CELLPACK DCL, [CELLPACK DCL aspiration error] will appear. Replace the CELLPACK DCL container and then click [Execute] in the help dialog box to replenish the reagent. After replenishing of the reagent is completed, execute reagent replacement from the [Reagent Replacement] dialog box and register the reagent. This will take longer than regular reagent replacement.
After reagent replacement, execute automatic rinsing and make sure that each parameter is below the allowed blank value.

Follow the steps below to configure the settings.



1 Remove the dispensing set from the RU-20 supply tank.

2 Attach the dispensing set to the CELLPACK DCL.

Attach the dispensing set that you removed from the RU-20 supply tank to the CELLPACK DCL.

3 Click the RU menu button in the control menu.

The dialog box on the right appears.

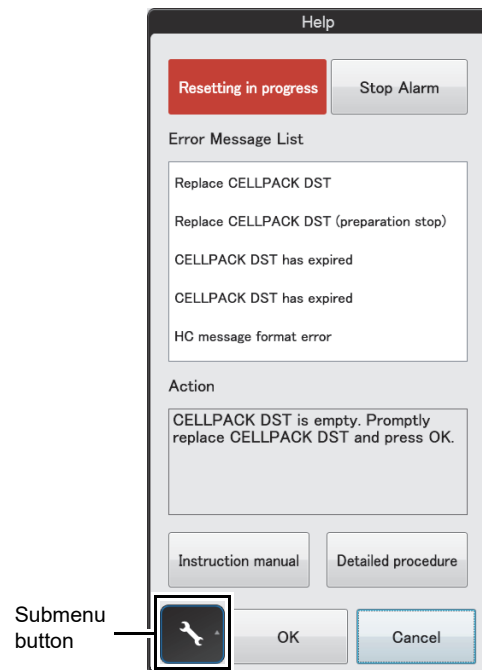

4 Click the submenu button.

The submenu on the right appears.

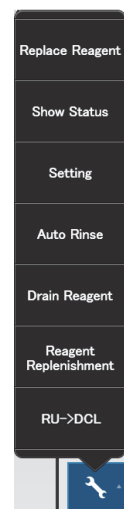

5 Click [RU->DCL].

The confirmation dialog box appears.

6 Click [OK].

Help dialog box appears.

7 Click [Execute].

The [Reagent Replacement] dialog box appears.
Register the CELLPACK DCL.

4.6.3 End temporary use of CELLPACK DCL

To reset the RU-20, end temporary use of CELLPACK DCL.
Follow the steps below to configure the settings.



1 Remove the dispensing set from the CELLPACK DCL.

2 Attach the dispensing set to the RU-20 supply tank.

Attach the dispensing set that you removed from the CELLPACK DCL to the RU-20 supply tank.

3 Click the RU menu button in the control menu.

The dialog box on the right appears.

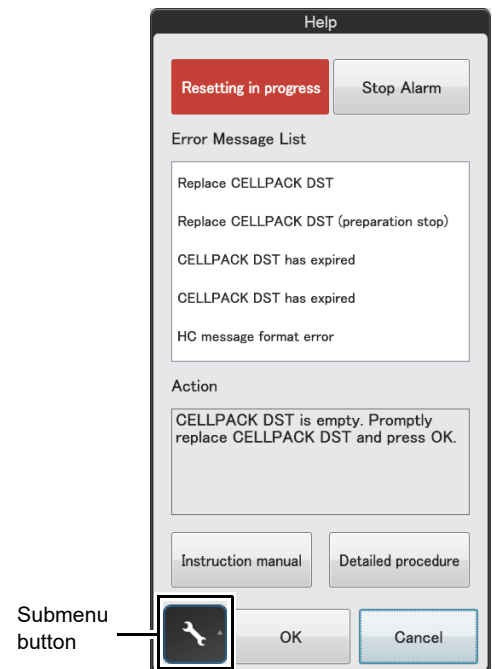

4 Click the submenu button.

The submenu on the right appears.

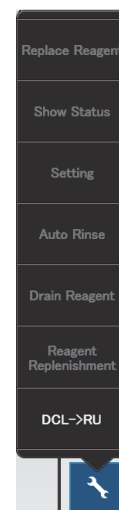

5 Click [DCL->RU].

The confirmation dialog box appears.

6 Click [OK].

The alarm temporarily sounds.

End temporary use of CELLPACK DCL, and use RU-20.

Chapter 5 Appendix

5.1 Interface Protocol

Data can be output in various formats via the serial interface. For details, please contact the Service Department of your local Sysmex representative.

5.2 Transportation controller connections (CT-90)

5.2.1 Flow of data of the system (XN-9000)

The flow of data in the system is as shown below when the XN-9000 is used.

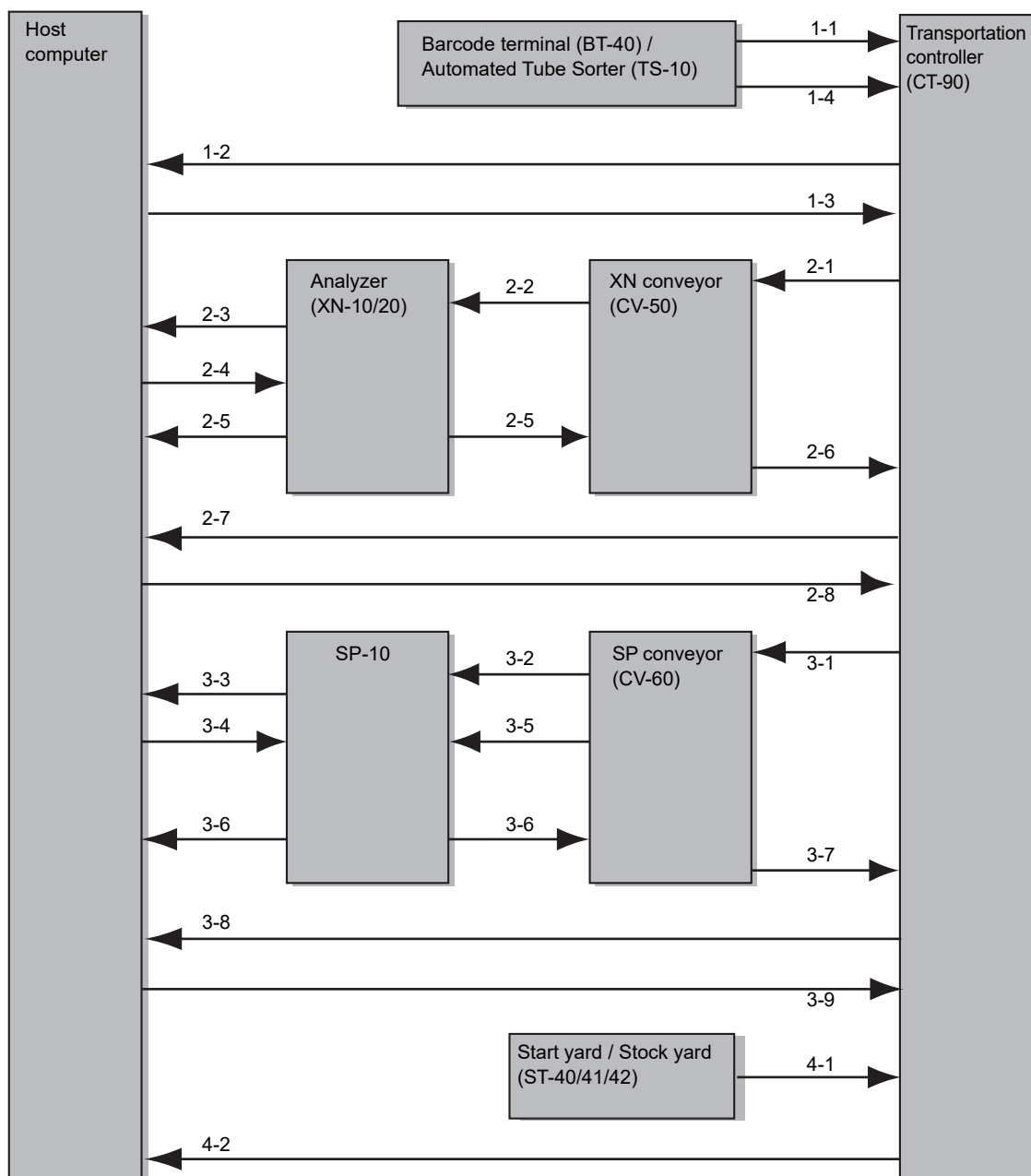

1 Determining the conveying destination

1	Barcode terminal (BT-40) / Automated Tube Sorter (TS-10)	Reads the sample/rack label and sends the sample position information to the transportation controller.
2	Transportation controller (CT-90)	Sends the sample position information to the host computer.
3	Host computer	Sends the sample analysis order by rack to the transportation controller.
4	Barcode terminal (BT-40) / Automated Tube Sorter (TS-10)	Reads the barcode label at the carry-out position, and sends the rack number to the transportation controller.
5	Transportation controller (CT-90)	Identifies the rack and determines the conveying destination.

2 Analysis

1	Transportation controller (CT-90)	Sends an order to the XN conveyor (CV-50) for a rack to be conveyed.
2	XN conveyor (CV-50)	Sends the order for the rack to be conveyed to Analyzer (XN-10/20).
3	Analyzer (XN-10/20)	The sample to be analyzed is identified from the order and the host computer is queried for the sample information.
4	Host computer	Sends the sample analysis order.
5	Analyzer (XN-10/20)	Performs analysis based on the received order. Sends the analysis data to the host computer. When analysis is finished, sends the analysis result to the XN conveyor (CV-50). Repeats the above until there are no more samples to be analyzed.
6	XN conveyor (CV-50)	Sends the analysis result to the transportation controller.
7	Transportation controller (CT-90)	Sends a query about an additional order.
8	Host computer	Whether or not an additional order exists and a description of the order are sent.

3 Smear analysis

1	Transportation controller (CT-90)	Sends an order to the SP conveyor (CV-60) for a rack to be conveyed.
2	SP conveyor (CV-60)	Identifies the sample to be analyzed based on the order and reads the barcode label. Sends the sample number that was read to the SP-10.
3	SP-10	Queries the host computer for sample information.
4	Host computer	Sends the sample analysis order to the SP-10.
5	SP conveyor (CV-60)	Instructs the SP-10 to aspirate the sample to be analyzed.
6	SP-10	Performs analysis based on the received order. Sends the smear result and stain result to the host computer and SP conveyor (CV-60).
7	SP conveyor (CV-60)	Sends the smear result and stain result to the transportation controller.
8	Transportation controller (CT-90)	Sends a query about an additional order.
9	Host computer	Whether or not an additional order exists and a description of the order are sent.

4 Storage

1	Start yard/Stock yard (ST-40/41/42)	Notifies the transportation controller that the rack has arrived.
2	Transportation controller (CT-90)	Creates rack storage information and sends it to the host computer.

5.2.2 Flow of data of the system (XN-9100)

The flow of data in the system is as shown below when the XN-9100 is used.

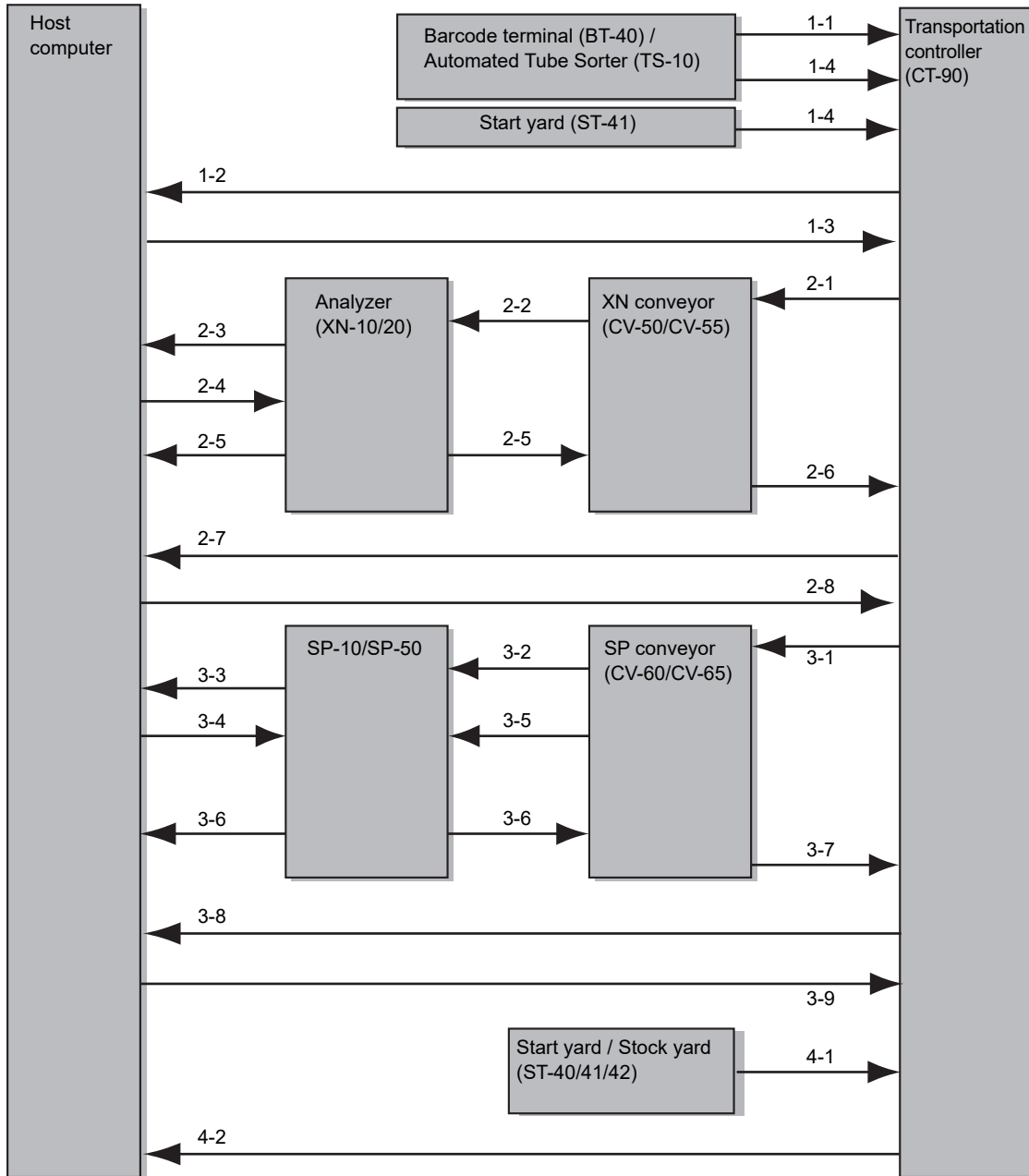

1 Determining the conveying destination

		When the barcode terminal (BT-40) or Automated Tube Sorter (TS-10) is used	When the barcode terminal (BT-40) or Automated Tube Sorter (TS-10) is not used
1	Barcode terminal (BT-40) / Automated Tube Sorter (TS-10)	Reads the sample/rack label and sends the sample position information to the transportation controller.	
2	Transportation controller (CT-90)	Sends the sample position information to the host computer.	
3	Host computer	Sends the sample analysis order by rack to the transportation controller.	
4	Barcode terminal (BT-40) / Automated Tube Sorter (TS-10) / Start yard (ST-41)	Reads the barcode label at the carry-out position, and sends the rack number to the transportation controller.	
5	Transportation controller (CT-90)	Identifies the rack and determines the conveying destination.	

2 Analysis

		When the barcode terminal (BT-40) or Automated Tube Sorter (TS-10) is used	When the barcode terminal (BT-40) or Automated Tube Sorter (TS-10) is not used
1	Transportation controller (CT-90)	Sends an order to the XN conveyor (CV-50/CV-55) for a rack to be conveyed.	
2	XN conveyor (CV-50/CV-55)	Sends the order for the rack to be conveyed to Analyzer (XN-10/20). For the XN conveyor (CV-55), reads the barcode label. Sends the sample number that was read to Analyzer (XN-10/20).	Reads the barcode label. Sends the sample number that was read to Analyzer (XN-10/20).
3	Analyzer (XN-10/20)	The sample to be analyzed is identified from the order and the host computer is queried for the sample information. If the barcode label is read on the XN conveyor (CV-55), the sample number sent from the XN conveyor (CV-55) is prioritized and queried to the host computer.	Queries the host computer for sample information.
4	Host computer	Sends the sample analysis order to Analyzer (XN-10/20).	
5	Analyzer (XN-10/20)	Performs analysis based on the received order. Sends the analysis data to the host computer. When analysis is finished, sends the analysis result to the XN conveyor (CV-50/CV-55). Repeats the above until there are no more samples to be analyzed.	
6	XN conveyor (CV-50/CV-55)	Sends the analysis result to the transportation controller.	
7	Transportation controller (CT-90)	Sends a query about an additional order.	
8	Host computer	Whether or not an additional order exists and a description of the order are sent.	

3 Smear analysis

1	Transportation controller (CT-90)	Sends an order to the SP conveyor (CV-60/CV-65) for a rack to be conveyed.
2	SP conveyor (CV-60/CV-65)	Identifies the sample to be analyzed based on the order and reads the barcode label. Sends the sample number that was read to the SP-10/SP-50.
3	SP-10/SP-50	Queries the host computer for sample information.
4	Host computer	Sends the sample analysis order to the SP-10/SP-50.
5	SP conveyor (CV-60/CV-65)	Instructs the SP-10/SP-50 to aspirate the sample to be analyzed.
6	SP-10/SP-50	Performs analysis based on the received order. Sends the smear result and stain result to the host computer and SP conveyor (CV-60/CV-65).
7	SP conveyor (CV-60/CV-65)	Sends the smear result and stain result to the transportation controller.
8	Transportation controller (CT-90)	Sends a query about an additional order.
9	Host computer	Whether or not an additional order exists and a description of the order are sent.

4 Storage

1	Start yard/Stock yard (ST40/41/42)	Notifies the transportation controller that the rack has arrived.
2	Transportation controller (CT-90)	Creates rack storage information and sends it to the host computer.

5.2.3 Communication connection chart

Communication connections are as shown below when the XN-9000/XN-9100 is used.

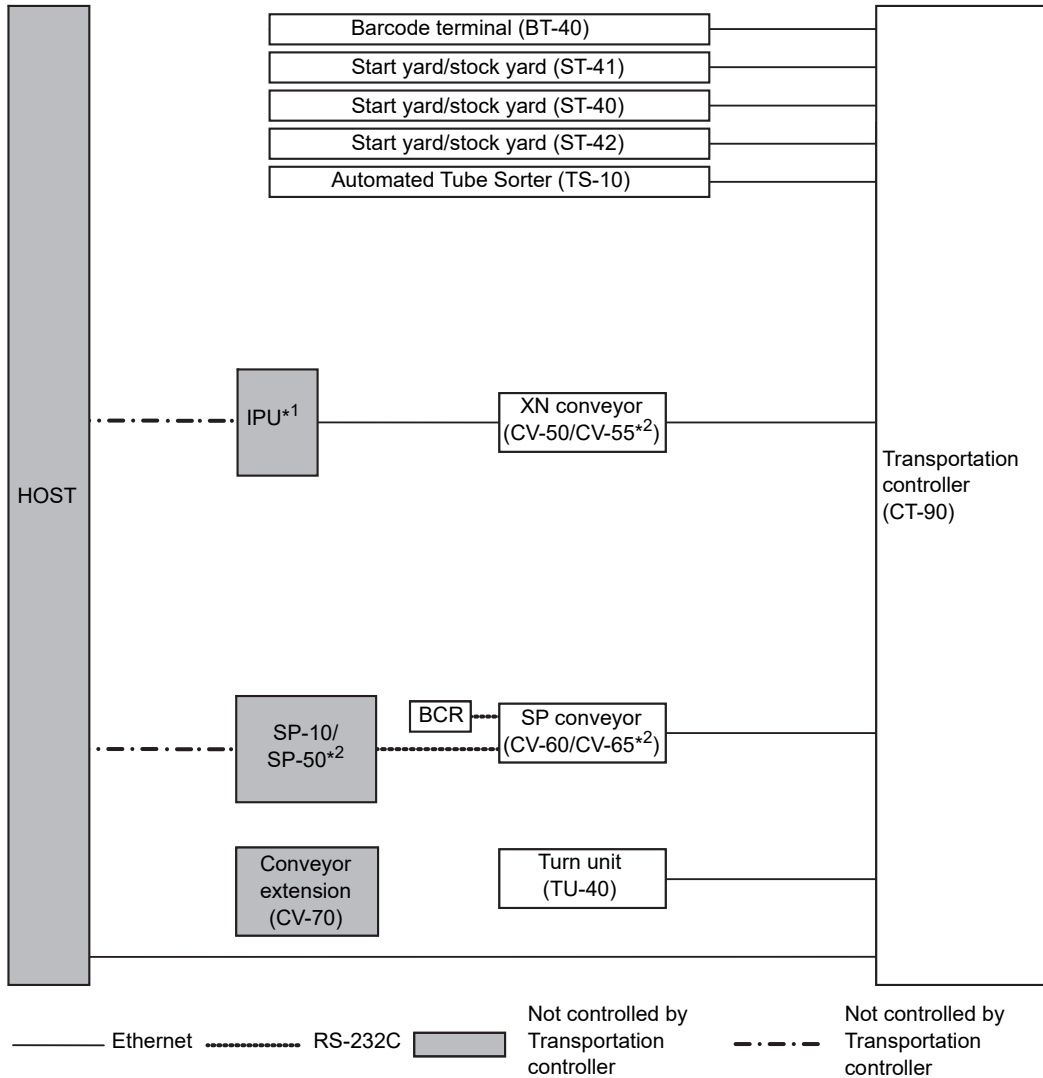

*1 The number of IPU's to be connected varies depending on the combination of the XN conveyors (CV-50/CV-55).

*2 This can be used only when XN-9100 is used.

5.3 ID Barcode specifications

Barcode labels can be affixed to sample tubes and racks to enable automatic reading of the ID by barcode reader. This section explains the specifications of barcode labels that can be read by the barcode reader of this machine.

5.3.1 Acceptable barcodes

The types of barcodes that can be used and check digit support are listed below.

Sample number

Barcode type	Check digit	Number of digits
ITF	Not used	Max. 22 digits (sample ID)
	Modulus 10	Max. 21 digits (sample ID) + 1 digit (check digit) = Max. 22 digits
CODABAR/ NW7	Not used	Max. 22 digits (sample ID)
	Modulus 11	Max. 22 digits (sample ID) + 1 digit (check digit) = Max. 23 digits
	Weighted Modulus 11	
	Modulus 16	
CODE 39	Not used	Max. 22 digits (sample ID)
	Modulus 43	Max. 22 digits (sample ID) + 1 digit (check digit) = Max. 23 digits
JAN/EAN/UPC	Modulus 10	12 digits (sample ID) + 1 digit (check digit) = 13 digits
ISBT 128	Modulus 103	Max. 22 digits (sample ID) + 1 digit (check digit) = Max. 23 digits
CODE 128	Modulus 103	Max. 22 digits (sample ID) + 1 digit (check digit) = Max. 23 digits



Information

- Do not use a rack ID barcode as a barcode for a sample ID.
- When using CODE 128, do not use the codes below.

Code	CODE A	CODE B
95	US	DEL
96	FNC 3	FNC 3
97	FNC 2	FNC 2
98	SHIFT	SHIFT
99	CODE C	CODE C
100	CODE B	FNC 4

Code	CODE A	CODE B
101	FNC 4	CODE A
102	FNC 1	FNC 1
103	START(CODE A)	
104	START(CODE B)	
105	START(CODE C)	



Note:

In CODE 128, any one of the characters "A", "B", "C", "a", "b" or "c" can be used for the start/stop code.

Rack number

Barcode type	Check digit	Number of digits
CODABAR/NW7	Modulus 16	6 digits (rack number) + 1 digit (check digit) = 7 digits
CODE 39	Modulus 43	6 digits (rack number) + 1 digit (check digit) = 7 digits

* When the transportation controller (CT-90) is used, this does not appear.



Information

Use either "D" or "d" for the start/stop code.

The reservation number of the special rack (XN-9000)

This section explains the reservation numbers for special racks that are used when the XN-9000 is used.

The reservation numbers of the special racks are as follows:

SR****

00:	The sample positions in the rack are associated with units in the system, and the samples are conveyed accordingly. The sample that is placed in rack position 10 is conveyed to conveyor "CV1". The sample that is placed in rack position 9 is conveyed to conveyor "CV2". Similarly, the samples in sample positions through position 1 are conveyed to the respectively associated units. However, QC samples are conveyed to all conveyors in sequential order.
01 to 10:	The number on the rack label is associated with the unit configuration, and sample is transported. If the number of the rack label is "01", it is transported to conveyor "CV1". If the number of the rack label is "02", it is transported to conveyor "CV2". Similarly thereafter, all rack label numbers up to number "10" are associated with, and transported to, their respective units*. * CV1 is the conveyor (CV-50, CV-60) connected to the rack discharge side of the barcode terminal (BT-40). From there on, the conveyors are enumerated in sequential order as CV2, CV3, and so on.
H:	The racks are transported for analyzer only.
A:	Conveying is possible for all analyzers connected to the conveyor controller* ¹ .
S:	Indicates the reservation number for Shutdown.
R:	Indicates the reservation number for Auto Rinse.
Q:	Indicates the reservation number for QC.
SR:	Indicates the reservation number for Special Rack* ² .

*¹ Special racks for QC are not conveyed to SP-10.

*² In addition to "SR****", the reserved numbers "NOR****", "SAR****", "RBT****", and "ERR****" are also used for special racks. For more information, please contact your local dealer or Sysmex Representative.

The reservation number of the special rack (XN-9100)

This section explains the reservation numbers for special racks that are used when the XN-9100 is used. The reservation numbers of the special racks are as follows:

SR****

00:	The sample positions in the rack are associated with the conveying destination as follows, and the samples are conveyed accordingly.																								
	<table border="0" style="margin-left: 40px;"> <tr> <td style="border-bottom: 1px solid black;">Sample position*¹</td> <td style="border-bottom: 1px solid black;">10</td> <td style="border-bottom: 1px solid black;">to</td> <td style="border-bottom: 1px solid black;">1</td> </tr> <tr> <td>Conveying destination*²</td> <td>CV1</td> <td>to</td> <td>CV10</td> </tr> </table>	Sample position* ¹	10	to	1	Conveying destination* ²	CV1	to	CV10																
Sample position* ¹	10	to	1																						
Conveying destination* ²	CV1	to	CV10																						
01 to 12:	The number on the rack label is associated with the conveying destination as follows, and the samples are conveyed accordingly.																								
	<table border="0" style="margin-left: 40px;"> <tr> <td style="border-bottom: 1px solid black;">Last numbers of rack label</td> <td style="border-bottom: 1px solid black;">01</td> <td style="border-bottom: 1px solid black;">to</td> <td style="border-bottom: 1px solid black;">12</td> </tr> <tr> <td>Conveying destination*²</td> <td>CV1</td> <td>to</td> <td>CV12</td> </tr> </table>	Last numbers of rack label	01	to	12	Conveying destination* ²	CV1	to	CV12																
Last numbers of rack label	01	to	12																						
Conveying destination* ²	CV1	to	CV12																						
A1 to A3:	The sample positions in the rack are associated with the conveying destination as follows, and the samples are conveyed accordingly.																								
	<ul style="list-style-type: none"> • For "A1": <table border="0" style="margin-left: 40px; margin-top: 10px;"> <tr> <td style="border-bottom: 1px solid black;">Sample position*¹</td> <td style="border-bottom: 1px solid black;">10</td> <td style="border-bottom: 1px solid black;">to</td> <td style="border-bottom: 1px solid black;">1</td> </tr> <tr> <td>Conveying destination*³</td> <td>XN/SP1</td> <td>to</td> <td>XN/SP10</td> </tr> </table> • For "A2": <table border="0" style="margin-left: 40px; margin-top: 10px;"> <tr> <td style="border-bottom: 1px solid black;">Sample position*¹</td> <td style="border-bottom: 1px solid black;">10</td> <td style="border-bottom: 1px solid black;">to</td> <td style="border-bottom: 1px solid black;">1</td> </tr> <tr> <td>Conveying destination*³</td> <td>XN/SP11</td> <td>to</td> <td>XN/SP20</td> </tr> </table> • For "A3": <table border="0" style="margin-left: 40px; margin-top: 10px;"> <tr> <td style="border-bottom: 1px solid black;">Sample position*¹</td> <td style="border-bottom: 1px solid black;">10</td> <td style="border-bottom: 1px solid black;">to</td> <td style="border-bottom: 1px solid black;">1</td> </tr> <tr> <td>Conveying destination*³</td> <td>XN/SP21</td> <td>to</td> <td>XN/SP30</td> </tr> </table> 	Sample position* ¹	10	to	1	Conveying destination* ³	XN/SP1	to	XN/SP10	Sample position* ¹	10	to	1	Conveying destination* ³	XN/SP11	to	XN/SP20	Sample position* ¹	10	to	1	Conveying destination* ³	XN/SP21	to	XN/SP30
Sample position* ¹	10	to	1																						
Conveying destination* ³	XN/SP1	to	XN/SP10																						
Sample position* ¹	10	to	1																						
Conveying destination* ³	XN/SP11	to	XN/SP20																						
Sample position* ¹	10	to	1																						
Conveying destination* ³	XN/SP21	to	XN/SP30																						
H:	The racks are transported for analyzer only.																								
A:	Conveying is possible for all analyzers connected to the conveyor controller* ⁴ .																								
S:	Indicates the reservation number for Shutdown.																								
R:	Indicates the reservation number for Auto Rinse.																								
Q:	Indicates the reservation number for QC.																								
SR:	Indicates the reservation number for Special Rack* ⁵ .																								

*1 1 is the sample position 1st from the left edge of the rack. From there on, the sample positions are enumerated in sequential order as 2, 3, and so on.

*2 CV1 is the conveyor (CV-50/55, CV-60/65) 1st from the right edge of the unit configuration. From there on, the conveyors are enumerated in sequential order as CV2, CV3, and so on.

*3 XN/SP1 is the unit 1st from the right edge of the unit configuration. From there on, the units are enumerated in sequential order as XN/SP2, XN/SP3, and so on.

*4 Special racks for QC are not conveyed to SP-10/SP-50.

*5 In addition to "SR****", the reserved numbers "NOR****", "SAR****", "RBT****", "ERR****" and "ADV****" are also used for special racks. For more information, please contact your local dealer or Sysmex Representative.

CELLCLEAN AUTO placement methods and required time

When using the XN-3000/3100/9000/9100, the CELLCLEAN AUTO vials can be placed together in specified positions in 1 rack and automatically conveyed to all instruments. However, the overall rinsing operation will take longer because the instruments will be rinsed sequentially (approximate time: 15 minutes per instrument).

- XN-3000/XN-3100: The placement positions in the rack correspond to the instruments as follows:
8th: SP-10/SP-50, 9th: Analyzer (left), 10th: Analyzer (right)
- XN-9000: Special rack with reservation number ending with "00".
- XN-9100: Special rack with reservation number ending with "00" or "A1" to "A3".

Quality control

Barcode type	Check digit	Number of digits
CODE 128	Modulus 103	3 digits (fixed character string "QC-") + 8 digits (lot number) + 1 digit (check digit) = 12 digits



Note:

The CODE 128 barcode for quality control is a special Sysmex code used for control blood.

Dimensions of barcode elements

Narrow Element $\geq 190 \mu\text{m}$

Wide Element $\leq 1.2 \text{ mm}$

Narrow Element $\leq \text{GAP between characters} \leq \text{Wide Element}$

Narrow/Wide ratio

For each character, the narrow/wide ratios must be as follows:

Narrow (Max) : Wide (Min) = 1 : 2.2 or more

Narrow (Min) : Narrow (Max) = 1 : 1.3 or less

Wide (Min) : Wide (Max) = 1 : 1.4 or less

PCS (Print Contrast Signal)

$$\text{PCS} = \frac{\text{Reflectivity of white} - \text{Reflectivity of black}}{\text{Reflectivity of white}}$$

The measurement method conforms to JIS (Japanese Industrial Standards) x0501, "5.3 Optical Characteristics of Bar Code Symbols".

Standard: $\text{PCS} \geq 0.45$

Print quality of barcode label

Use barcode labels of Label Grade C or higher of the ANSI standards.

Reading of laminated labels may not be possible.

Irregularity and roughness of printing

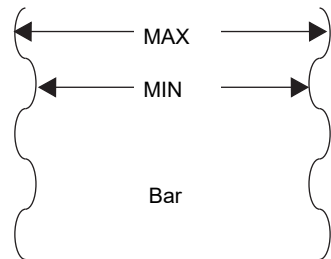

When a bar is magnified, it appears as shown at left.
Expressing the variation in the width of a bar as

$$S = \frac{\text{MAX} - \text{MIN}}{\text{MAX}} \times 100\%$$

S must be $\leq 20\%$.

Dimensions of sample tube barcode label

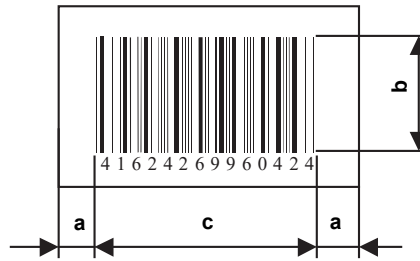

Margin	(Dimension a)	5 mm or more
Bar height	(Dimension b)	10 mm or more
Effective barcode part	(Dimension c)	48 mm or less
Narrow width	-	0.19 mm or more

Dimensions of tube rack barcode label

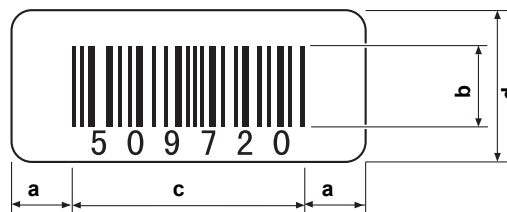

Margin	(Dimension a)	3 mm or more
Bar height	(Dimension b)	8 mm or more
Effective barcode part	(Dimension c)	45 mm or less
Label height	(Dimension d)	15 mm or less
Narrow bar:Wide bar	-	1:2.5

5.3.2 Automatic assignment of sample ID and rack numbers

A sample ID number or rack number is automatically assigned to samples for which a barcode label read error occurred or for which analysis started while the analysis order was still being downloaded.

An automatically assigned sample number starts with a symbol that distinguishes it from other sample numbers.

● Sample ID number

Number starting with [ERR]	Assigned when a barcode label read error occurs. A barcode label read error also occurs when a number includes characters that cannot be used. When a serial number is assigned and the limit number is exceeded, the number returns to [00....01].
Number starting with [QC]	Assigned to a QC sample with a lot number or a QC file.
[BACKGROUNDCHECK]	Assigned to a background check sample.
Number starting with [PRE-CHK]	Assigned to a precision check sample.
Number starting with [CAL-CAL]	Assigned to samples calibrated by calibrator calibration (parameters other than PLT-F).
Number starting with [PF-CAL-CAL]*	Assigned to samples calibrated by calibrator calibration (PLT-F).
Number starting with [ADV]	Assigned to samples conveyed from the start yard (ST-41) in the system configuration where the barcode terminal (BT-40) or Automated Tube Sorter (TS-10) is not used.

● Rack number

Automatically assigned rack numbers are 6 digits in length.

Number starting with [ERR]	Assigned when a rack label read error occurs. A barcode label read error also occurs when a number includes characters that cannot be used.
-----------------------------------	--



Information

Sample numbers starting with [QC] whose lower four digits are one of the following numbers are reserved.

- "1101", "1102", "1103": XN CHECK
- "1301", "1302": XN CHECK BF

5.3.3 Check digits

To improve the reliability of ID reading, a check digit can be added.

Using the sample ID "258416" as an example, the procedures for calculating the check digits for modulus 11 and weighted modulus 11 are explained below.

Modulus 11

1 Weight the value of each digit of "258416".

Digits and weightings are as follows.

Digit	22	21	20	19	18	17	16	15	14	13	12	11	10	9	8	7	6	5	4	3	2	1
Weighting	3	2	1	10	9	8	7	6	5	4	3	2	1	10	9	8	7	6	5	4	3	2

Calculate as follows.

Value of each digit	2	5	8	4	1	6
	x	x	x	x	x	x
Weighting	7	6	5	4	3	2
	14	30	40	16	3	12

e.g: The first digit of "258416" is "6", and thus "6" is multiplied by "2", the weighting of the first digit.

2 Add all the values that result from the multiplications.

Let the result be S.

$$S = 14 + 30 + 40 + 16 + 3 + 12 = 115$$

3 Calculate the remainder when S is divided by 11.

Calculate the complement of the remainder.

The complement of 11 will be the check digit.

$$115/11 = 10, \text{ remainder } 5$$

$$11 - 5 = 6$$

The check digit is 6.



Note:

Symbols and characters other than the numeric characters "0" to "9" are treated as "0". When division of S by 11 results in a remainder of 0, or when calculation of the check digit results in 10, 0 is used for the check digit.

Weighted modulus 11

Weighted modulus 11 has 2 sets of weightings for each digit. The check digit is first calculated with the first set of weightings. If the resulting check digit is 10, the check digit is calculated again using the second set of weightings. The result will always be a value from 0 to 9. Aside from the different weightings, the calculation procedure is the same as for modulus 11.

1 Weight the value of each digit of "258416".

Digits and weightings are as follows.

Weighting	W12	W11	W10	W9	W8	W7	W6	W5	W4	W3	W2	W1
1st set	6	3	5	9	10	7	8	4	5	3	6	2
2nd set	5	8	6	2	10	4	3	7	6	8	5	9

Calculate as follows.

Value of each digit	2	5	8	4	1	6
	x	x	x	x	x	x
Weighting	8	4	5	3	6	2
	16	20	40	12	6	12

2 Add all the values that result from the multiplications.

Let the result be S.

$$S = 16 + 20 + 40 + 12 + 6 + 12 = 106$$

3 Calculate the remainder when S is divided by 11.

Calculate the complement of the remainder.
The complement of 11 will be the check digit.

$$106/11 = 9, \text{ remainder } 7$$

$$11 - 7 = 4$$

The check digit is 4.



Note:

- Symbols and characters other than the numeric characters "0" to "9" are treated as "0". When division of S by 11 results in a remainder of 0, or when calculation of the check digit results in 10, 0 is used for the check digit.
- In weighted modulus 11, weightings for digits after the 12th digit (13th and higher digits) are 0. These are not included in the check digit calculation.

5.4 Default settings

5.4.1 Analyzer setting names and default settings

Sampler

Setting name		Default setting
Blood Sensor		Use
Sampler Analysis Start Settings* ¹		Sampler analysis starts when rack is placed in sampler
Sampler Stop Conditions	ID Read Error	Stop Sampler Analysis
	Rack ID Read Error* ²	Stop Sampler Analysis
	Blank Data	Stop Sampler Analysis
	Critical Value Data	Stop Sampler Analysis
	Aspiration Error	Stop Sampler Analysis
	Inadequate Sample	Stop Sampler Analysis
	QC Alarm	Do Not Stop Sampler Analysis
	X-barM Limit Error	Stop Sampler Analysis
	L-J Limit Error	Stop Sampler Analysis
	Control Expired Error	Stop Sampler Analysis
	Unregistered Control	Do Not Stop Sampler Analysis
	Reagent Expired Error	Do Not Stop Sampler Analysis
	Invalid Analysis Order	Stop Sampler Analysis
Command not to aspirate	Do Not Stop Sampler Analysis	
Repeat Setting* ³		Repeat
Rerun/Reflex Setting* ³		Rerun/Reflex
Sampler Discrete Settings		Specified discrete
CELLCLEAN AUTO Settings* ⁴		Return to rack

*1 When system analysis mode is selected on the XN-9000/XN-9100 or the sampler (SA-01) is used, this does not appear.

*2 When the transportation controller (CT-90) or the sampler (SA-01) is used, this does not appear.

*3 When the sampler (SA-01) is used, this does not appear.

*4 When the XN-1000, XN-1500, or XN-9000/XN-9100 is used, this does not appear.

Barcode Reader

Setting name		Default setting	
Barcode Reader Connection*1		Connect Barcode Reader	
Read Tube ID*1	Specify Sample No. Length	No	
	Check Digits Conditions	ITF	Use ITF
		Check Digit	Modulus-10
		CODABAR/NW7	Use CODABAR/NW7
		Check Digit	Modulus-16
		CODE39	Use CODE39
		Check Digit	Modulus-43
		JAN/EAN/UPC	Use JAN/EAN/UPC
		Check Digit	Modulus-10
		ISBT128	Do Not Use ISBT128
		CODE128	Use CODE128
		Check Digit	Modulus-103
		Rack ID*2	Do Not Read Rack ID
	Check Digits Conditions (when read)	CODABAR/NW7 Start-Stop Character/D(d)-D(d) Modulus 16	
Setting for Ordering Key Read Error		Analyzed	

*1 When the XN-3000/XN-3100 (Standalone mode) or the transportation controller (CT-90) is used, this is always connected. The setting is grayed out and cannot be modified.

*2 When the transportation controller (CT-90) or the sampler (SA-01) is used, this does not appear.

Alarm

Setting name	Default setting
Warning	Loop
Stops Analysis	Loop

Smart indicator

Setting name	Default setting
LED settings	Orange

RU name setting

Setting name	Default setting
RU-1	RU-1
RU-2	RU-2

System

Setting name			Default setting
Identification	Instrument Name*	XN-1000	XN-1000-#
		XN-1500	XN-1500-#
		XN-2000	XN-2000-#
		XN-3000	XN-3000-#
		XN-3100	XN-3100-#
		XN-9000	XN-9000-#
		XN-9100	XN-9100-#
	Sampler Name Suffix		-S
	Analyzer Name Suffix	XN-1000, XN-1500	-A
		XN-2000, XN-3000/XN-3100	Left Analyzer: -L Right Analyzer: -R
XN-9000		-A	
XN-9100 (If connected to CV-50)		-A	
XN-9100 (If connected to CV-55)		Left Analyzer: -L Right Analyzer: -R	

* "#" at the end of the instrument name and instrument abbreviation indicates a serial number appended to an instrument that connects to the IPU. Numbers 1 to 3 are assigned by the system.

Flags

Flag	Judgment	Judgment value setting*1		
WBC Abnormal Flags				
Neutropenia	Judge	NEUT# < 1.00[x10 ³ /uL]	or	NEUT% < 0.0[%]
Neutrophilia	Judge	NEUT# > 11.00[x10 ³ /uL]	or	NEUT% > 100.0[%]
Lymphopenia	Judge	LYMPH# < 0.80[x10 ³ /uL]	or	LYMPH% < 0.0[%]
Lymphocytosis	Judge	LYMPH# > 4.00[x10 ³ /uL]	or	LYMPH% > 100.0[%]
Monocytosis	Judge	MONO# > 1.00[x10 ³ /uL]	or	MONO% > 100.0[%]
Eosinophilia	Judge	EO# > 0.70[x10 ³ /uL]	or	EO% > 100.0[%]
Basophilia	Judge	BASO# > 0.20[x10 ³ /uL]	or	BASO% > 100.0[%]
Leukocytopenia	Judge	WBC < 2.50[x10 ³ /uL]		
Leukocytosis	Judge	WBC > 18.00[x10 ³ /uL]		
NRBC Present	Judge	NRBC% > 2.0[%]		
IG Present	Judge	IG# > 0.10[x10 ³ /uL]	or	IG% > 100.0[%]
RBC Abnormal Flags				
Reticulocytosis	Judge	RET# > 0.2000[x10 ⁶ /uL]	or	RET% > 5.00[%]
Anisocytosis	Judge	RDW-SD > 65.0[fL]	or	RDW-CV > 20.0[%]
Microcytosis	Judge	MCV < 70.0[fL]		
Macrocytosis	Judge	MCV > 110.0[fL]		
Hypochromia	Judge	MCHC < 29.0[g/dL]		
Anemia	Judge	HGB < 10.0[g/dL]		
Erythrocytosis	Judge	RBC > 6.50[x10 ⁶ /uL]		
PLT Abnormal Flags				
Thrombocytopenia	Judge	PLT < 60[x10 ³ /uL]		
Thrombocytosis	Judge	PLT > 600[x10 ³ /uL]		
Wbc Abnormal Flags (Body Fluid Analysis)*2				
WBC Abn Scattergram	Do Not Judge	HF-BF# > 999.999[x10 ³ /uL]	or	HF-BF% > 100.0/100WBC

*1 The decimal point symbol set in Windows is displayed in the XN Series.

The only decimal point symbols displayed are "." (period) or "," (comma).

*2 The body fluid analysis can only be performed if the instrument offers the body fluid analysis mode.

Critical Value

Setting name		Default setting
Critical Value Settings	Item	WBC
	Lower Limit	WBC Lower Limit
	Upper Limit	WBC Upper Limit

Items	Lower Limit*	Upper Limit*	Unit
WBC	0.00	999.99	x10 ³ /uL
RBC	0.00	99.99	x10 ⁶ /uL
HGB	0.0	999.9	g/dL
HCT	0.0	999.9	%
MCV	0.0	999.9	fL
MCH	0.0	999.9	pg
MCHC	0.0	999.9	g/dL
PLT	0	9999	x10 ³ /uL
RDW-SD	0.0	999.9	fL
RDW-CV	0.0	999.9	%
PDW	0.0	999.9	fL
MPV	0.0	999.9	fL
P-LCR	0.0	999.9	%
PCT	0.00	99.99	%
NRBC#	0.00	999.99	x10 ³ /uL
NRBC%	0.0	9999.9	%
NEUT#	0.00	999.99	x10 ³ /uL
LYMPH#	0.00	999.99	x10 ³ /uL
MONO#	0.00	999.99	x10 ³ /uL
EO#	0.00	999.99	x10 ³ /uL
BASO#	0.00	999.99	x10 ³ /uL
NEUT%	0.0	999.9	%
LYMPH%	0.0	999.9	%
MONO%	0.0	999.9	%
EO%	0.0	999.9	%
BASO%	0.0	999.9	%
IG#	0.00	999.99	x10 ³ /uL

Items	Lower Limit*	Upper Limit*	Unit
IG%	0.0	999.9	%
AS-LYMP#	0.00	999.99	x10 ³ /uL
AS-LYMP%	0.0	999.9	%
RE-LYMP#	0.00	999.99	x10 ³ /uL
RE-LYMP%	0.0	999.9	%
NEUT-RI	0.0	999.9	Fl
NEUT-GI	0.0	999.9	SI
MacroR	0.0	999.9	%
MicroR	0.0	999.9	%
RET%	0.00	99.99	%
RET#	0.0000	0.9999	x10 ⁶ /uL
IRF	0.0	999.9	%
LFR	0.0	999.9	%
MFR	0.0	999.9	%
HFR	0.0	999.9	%
RET-He	0.0	999.9	pg
RBC-He	0.0	999.9	pg
Delta-He	-999.9	999.9	pg
HYPO-He	0.0	999.9	%
HYPER-He	0.0	999.9	%
IPF	0.0	999.9	%
IPF#	0.0	999.9	x10 ³ /uL

* The decimal point symbol set in Windows is displayed in the XN Series.
The only decimal point symbols displayed are "." (period) or "," (comma).

Sample number auto increment

Setting name	Default setting
Sample No. Auto Increment Setting	Do not automatically increment (manual mode)

Analyzer

Setting name	Default setting
Aspiration Sensor	Use
Leak Sensor	When a water leak is detected, do not continue analysis.
Manual Discrete Settings	Discrete when last ended

SP Setting*¹

Setting name		Default setting
SP Rule Setting* ²	Perform Judgement of SP Rule	ON
Default SP Order* ²	Number of slide	Do not prepare slides
	slide glass(1st)/slide glass(2nd) (When prepared)	either
	Deliver to DIA (When specified)	OFF
Output to Host Computer setting	Output analysis result(SP) to Host Computer	OFF
	Output reagent replacement information(SP) to Host Computer	OFF
SP printer setting	Print Format	Type 1
	Print data	[1st text] to [3rd text], [Barcode]

*1 Only when using the XN-1500 or XN-3000/XN-3100 (Standalone mode).

*2 May not appear, depending on the instrument settings.

5.4.2 IPU setting names and default settings

System

Setting name		Default setting	
Facility Information	Facility Name	None	
System Language	Language	English	
	Print Language	English	
IPU Shutdown		Automatically Shut Down IPU	
General Date Format		YYYY/MM/DD	
User Administration	Auto Logon	No	
CSV Output Setting	Image File Output		Do Not Output Image File
		Image Format (when output)	PNG
		Background Color (when output)	BLACK
		Output sub scattergrams.	Do Not Output
		If output items exceed 256 columns, data will be divided into multiple files. (when output)	Divide Files
Security Setting	Analysis Data	Backup Data	Do not include patient information
		CSV File	Do not output patient information
	IPU Screen Lock		Do Not Use
Screen Keyboard Setting		Do Not Use	
Patient ID Display Setting		Right-justified	
Program Update Notification Setting		Do Not Use	
Database Optimization		Middle	

Display

Setting name				Default setting
Data Grid	Line Height	Setting	1	20 px
			2	22 px
			3 (default)	27 px
			4	32 px
			5	50 px
	Font Size	Setting	1	11 pt
			2	13 pt
			3 (default)	16 pt
			4	19 pt
			5	26 pt
Scattergram	Background Color			BLACK

Connection

Setting name		Default setting	
Host Computer Connection		Do not connect to host	
	Current Connection (when host computer connection is ON)	Host Computer 1	
	Serial Connection (when host computer connection is ON)	OFF	
	Port Settings	COM1	
	Port Settings	Baud Rate	9600
		Code	8-bit
		Stop Bit	1-bit
		Parity Bit	None
		Interval	2
	Class	ClassB	
	Format	XN series Sysmex Standard	
	TCP/IP Connection (when host computer connection is ON)	ON	
		HOST IP Address	IPv4 (1.1.1.1)
Port No.		5000	
Format		XN series Sysmex Standard	
Ticket (DP) Setting	DP Connection	Do not connect to DP	
	Select Printer (when DP connection is ON)	TM-U295	
	Print Format	Sample No. Length	15
		Date Print Type	YYMMDD
		Delimiter of Date	/
		Print Decimal Point	Printed
		Top Margin	16 1/60 inch (8 - 255)
		Char. Pitch	7 dot (5 - 21)
		Line Pitch	8 1/60 inch (8 - 255)
Print Headstand	No		
Ticket (DP) Print Format Setting	Item Conditions	Printed	Varies by item.
		Print Condition	Varies by item. (All Samples/Negative)
	Print Start Position	Manual	

Setting name		Default setting
Printer Connection Settings	Report (GP) Connect	Connect to GP
	Ledger (LP) Connect	Connect to LP
IC Card Reader Connection Settings	Serial port	Do not use

Automatic processing

Setting name		Default setting
Auto Validate		Do Not Auto Validate
	Auto Validate Setting Procedure (when auto validate is ON)	Use simple settings
	Auto Validate Sample (when simple settings are used)	All Samples
Auto Output		Do Not Auto Output
	Auto Output Setting Procedure (when auto output is ON)	Use simple settings
	Error Data Output Conditions	Do not automatically output data with errors
	Auto Output Destination and Output Conditions	Do Not Use
Analysis Ordering	Key Setting	Sample No.
	Realtime Host Order Setting	Realtime Request: No
Delta Check Setting		Do Not Use

Reference interval

Setting name	Default setting						
Patient Category Settings							Use Category
	Lower Age Limit			Upper Age Limit			
	Year	Month	Week	Year	Month	Week	Sex
Category 1	0	0	0	0	0	1	Both
Category 2	0	0	1	0	1	0	Both
Category 3	0	1	0	1	0	0	Both
Category 4	1	0	0	12	0	0	Both
Category 5	12	0	0	60	0	0	Male
Category 6	12	0	0	60	0	0	Female
Category 7	60	0	0	999	0	0	Both

Item	Lower limit*	Upper limit*	Units
WBC	3.00	15.00	x10 ³ /uL
RBC	2.50	5.50	x10 ⁶ /uL
HGB	8.0	17.0	g/dL
HCT	26.0	50.0	%
MCV	86.0	110.0	fL
MCH	26.0	38.0	pg
MCHC	31.0	37.0	g/dL
PLT	50	400	x10 ³ /uL
RDW-SD	37.0	54.0	fL
RDW-CV	11.0	16.0	%
PDW	9.0	17.0	fL
MPV	9.0	13.0	fL
P-LCR	13.0	43.0	%
PCT	0.17	0.35	%
NEUT#	1.50	7.00	x10 ³ /uL
LYMPH#	1.00	3.70	x10 ³ /uL
MONO#	0.00	0.70	x10 ³ /uL
EO#	0.00	0.40	x10 ³ /uL
BASO#	0.00	0.10	x10 ³ /uL
NEUT%	37.0	72.0	%
LYMPH%	20.0	50.0	%

Item	Lower limit*	Upper limit*	Units
MONO%	0.0	14.0	%
EO%	0.0	6.0	%
BASO%	0.0	1.0	%
IG#	0.00	7.00	x10 ³ /uL
IG%	0.0	72.0	%
AS-LYMP#	0.00	999.99	x10 ³ /uL
AS-LYMP%	0.0	999.9	%
RE-LYMP#	0.00	999.99	x10 ³ /uL
RE-LYMP%	0.0	999.9	%
NEUT-RI	0.0	999.9	Fl
NEUT-GI	0.0	999.9	SI
MacroR	0.0	999.9	%
MicroR	0.0	999.9	%
RET%	0.00	99.99	%
RET#	0.0000	0.9999	x10 ⁶ /uL
IRF	0.0	100.0	%
LFR	0.0	100.0	%
MFR	0.0	100.0	%
HFR	0.0	100.0	%
RET-He	0.0	99.9	pg
RBC-He	0.0	999.9	pg
Delta-He	0.0	999.9	pg
HYPO-He	0.0	999.9	%
HYP-He	0.0	999.9	%
IPF	0.0	99.9	%
IPF#	0.0	999.9	x10 ³ /uL

* The decimal point symbol set in Windows is displayed in the XN Series.
The only decimal point symbols displayed are "." (period) or "," (comma).

Units

Item	Units	Format*1
WBC	10 ³ /uL	*** **
RBC	10 ⁶ /uL	** **
HGB	g/dL	**** *
HCT	%	*** *
MCV	fL	*** *
MCH	pg	*** *
MCHC	g/dL	*** *
PLT	10 ³ /uL	****
RDW-SD	fL	*** *
RDW-CV	%	*** *
PDW	fL	*** *
MPV	fL	*** *
P-LCR	%	*** *
PCT	%	** **
DIFF#	10 ³ /uL	*** **
DIFF%	%	*** *
NEUT-RI*2	FI	*** *
NEUT-GI*2	SI	*** *
HPC#*2	10 ³ /uL	** ****
RET#*3	10 ⁶ /uL	0.****
RET%*3	%	** **
IRF*3	%	*** *
IPF*3	%	*** *
NRBC%	%	**** *
WBC-BF*2	10 ³ /uL	*** ****
RBC-BF*2	10 ⁶ /uL	** ****

*1 The decimal point symbol set in Windows is displayed in the XN Series.

The only decimal point symbols displayed are "." (period) or "," (comma).

*2 The availability of these functions depends on your system configuration.

*3 These items do not appear with all analyzer types.

Quality control

Setting name			Default setting	
QC Setting	QC Method Setting		L-J	
	Limit Setting		Differential (#)	
	Auto Limit Setting		2SD	
	X-barM Batch Setting	Number of CBC Samples		20
		Number of DIFF Samples		20
		Number of RET Samples*		20
Number of PLT-F Samples*		20		
Number of WPC Samples*		20		
QC Alarm Setting			Do Not Use Alarm	
QC Chart Fixed Comment			Do Not Use	
QC Chart Data Auto Output Setting	QC Chart Screen	Automatically output plot data to host computer.		QC Files (Excluding X-barM) X-barM Files
	Explorer Screen	Output analysis results of sample numbers starting with QC to location below.	Graphic Printer (GP)	Do not output
			Host Computer (HC)	Do not output
			Ticket Printer (DP)	Do not output

* These discrete samples do not appear with all analyzer types.

Priority code

Setting name	Default setting		
No.	Code	Back Color	Description
1	S	No back color	STAT
2	R	No back color	Routine
3	T	No back color	Timed
4 to 15	Blank	No back color	Blank

5.4.3 Transportation controller setting names and default settings (CT-90)

List of settings and default settings when the XN-9000/XN-9100 is used.

Setting name				Default setting
Syst. Setting	Default conveyor destination when host order is not received	XN	Initial	Transport
			Repeat	Do not transport
		SP		Do not transport
	Default conveyor destination when there is a sample number reading error	XN	Initial	Transport
			Repeat	Do not transport
		SP		Do not transport
Host CX set.				Connect to host

Index

A

Acceptable barcodes	133
Alarm sound	59
Analysis ordering	98
Analysis Start	62
Analysis Stop	63
Analyzer name	67
Analyzer settings.....	53, 71
Auto output.....	97
Auto validate	96
Automatic assignment numbers.....	138
Automatic processing settings	96

B

Barcode	
Irregularity and roughness	
of printing.....	137
Label Dimensions	137
Quality control.....	136
Rack number	134
Sample number	133
Barcode reader	65
Basic system language	80
Blood aspiration sensor	71
Blood Sensor setting.....	62

C

Category	100
CELLCLEAN AUTO Settings	64
Change the display language	80
Character size.....	90
Check digits	139
Communication connection chart.....	132
Connection	
Graphic printer (GP)	95
Host computer	91
IC card reader.....	95
Items.....	91
List printer (LP).....	95
Ticket printer (DP)	93
Critical Value	70
CSV output.....	87

D

Data grid	90
Date format	80

Default

Analyzer.....	141
IPU.....	148
Transportation controller (CT-90)	156
Delta check	99
Discrete settings	
during manual analysis	72
Discrete settings	
during sampler analysis	64
Display and Modify Patient Info.....	83
Display and Output of Research Items	83

F

Facility information	79
Flag	
PLT	69
RBC	69
WBC	68
WBC (body fluid).....	69
Flag settings.....	68
Flow of data (the system)	
XN-9000.....	125
XN-9100.....	128
Frequency of database optimization	89

G

GP customize	
Function	108
Screen	109
Graphic printer (GP) connection	95
Graphic Printer print settings.....	108

H

Host computer connection	91
hsA analysis	49

I

IC card information	
Register	85
Reset	86
IC card reader connection.....	95
ID Barcode specifications.....	133
Interface Protocol	125
IPU screen lock timer	87
IPU settings.....	75

Items for research		Rule screens	
Body fluid	46	Output Rule	23
hsA	47	Repeat Rule	19
RBC/PLT	45	Rerun/Reflex Rule	20
WBC	44	Screens	19
L		SP Rule	21
Lab format	112	Validation Rule	22
List printer (LP) connection	95	Rules	
M		Disable	24
Manage settings		Enable	24
Analyzer	54	Execution Order	18
IPU	76	Initialize	29
N		Print	26
Notification of Program Updates	88	Save	27
O		Screen	17
Open the settings		Sort	25
Analyzer	51	Types	13
IPU	52	S	
Output rule	16	Sample ID numbers	138
P		Sample number auto increment	71
Patient ID display	88	Sampler settings	61
Print format	112	Screen keyboard	88
Printed items	111	Security	87
Priority code	107	Service data	
Prohibited Acts	11	ADJUSTMENT	42
Q		HARDWARE	41
QC		PLT-F	38
Alarm	104	RBC/PLT	32
Chart fixed comment	105	RET	36
Data auto output	106	WDF	35
Settings	103	WNR	34
R		WPC	39
Rack numbers	138	Service data check	31
Reference interval	101	Shutdown	80
Repeat	64	Smart indicator	60
Repeat rule	14	SP Rule	15
Report format	112	SP-10/SP-50 settings	72
Rerun/Reflex	64	Symbols	10
Rerun/Reflex/Comment rule	14	System settings	
Research data check	44	Analyzer	67
RU-20 name setting	61	IPU	79
RU-20 reagent switching		Reagent Unit (RU-20)	119
Restoring RU-20	123	Transportation controller (CT-90)	117
Temporary use of CELLPACK DCL	121	T	
		Ticket (DP) print format	94
		Ticket printer (DP) connection	93
		Transportation controller settings	117
		U	
		Units Setting	102

User information	
Add	83
Administration.....	81
Change settings.....	83
Change the password.....	82
Delete	85
Management.....	81
User permission	83

V

Validation rule	16
-----------------------	----

W

Water leak sensor	72
-------------------------	----

